

okay we're all set for your appointment on Tuesday afternoon we'll do the exam here and then the dentist can answer your questions sound okay no you don't need to bring anything with you if you need to reschedule just call our office see you on Tuesday

Press ▲ to Review the Conversation



## Action Needed – Registration

The Federal Communications Commission (FCC) requires that all *CapTel* 840i users register. As you set up your new phone, please follow the registration directions on the screen. The Captions feature cannot be activated until registration is complete. For directions, please see *Registering Your CapTel phone* on page 21.

Need help registering? Call 1-888-269-7477

## CapTel 840i Specifications

### Physical Dimensions

Size: 9" × 6.5" × 7.5"  
Weight: 2 lb. 10 oz.

### Power

AC Adapter: 6 VDC, 2 Amps  
(barrel is negative)  
Adapter is UL listed.

### Dial Pad

Large Keys: 0.75" × 0.70"

### Display

7" Backlit, graphical LCD  
color display  
840 × 480 pixels

### Function Buttons

3 Programmable Speed Dial  
1 Customer Service Speed Dial  
Redial  
Flash  
Mute  
Tone  
Caption  
Volume  
Up/Down/Yes/No

### Controls

Conversation: Amplification  
when Captions on: 0-40 dB gain  
when Captions off: 0-18 dB gain  
Tone  
Ringer: off, low, medium, high  
(0-87 dB at 1 meter)

### Indicator Lights

Mute  
Volume Levels (1 through 12)  
Captions On/Off

### Handset

Type: HAC (Hearing Aid  
Compatible)

### Dialing

Phone Book (97 entries)  
Speed Dial (3 entries)  
Redial (Last 10 dialed numbers)

### Captions

4 Caption font sizes

- Small 0.15"  
(14 lines of text)
- Medium 0.20"  
(10 lines of text)
- Large 0.25"  
(8 lines of text)
- Extra Large 0.33"  
(6 lines of text)

Adjustable colors for  
background and captions font

### Connections

Telephone line: requires RJ11  
connection (can be standard  
analog line, VOIP, DSL with  
filter, FIOS. Does not support  
digital PBX system unless  
analog port available).  
3.5 mm Neckloop/Headset  
2.5 mm Headset with microphone  
Ethernet or WiFi wireless network  
AC power

### Approvals

FCC approved  
ACTA Product-Labeling Number:  
US:D8KTE00BCAPTEL840  
REN: 0.0B

### Conversation Memory

500 lines of captions

### Caller ID History

Up to 99 entries

### Answering Machine

63 Recordable messages  
(2 minute max per message)  
Recordable greeting  
Selectable number of rings  
before answer  
Ability to caption messages  
left on an external answering  
machine

NOTE: Your *CapTel* phone will periodically connect to the Captioning Service through the Internet and/or phone line connection to report its status and check for software updates.

**WARNING:** *If the power supply is interrupted, you will lose all captions in memory.*

# Congratulations on Choosing *CapTel*!

Welcome to the Captioned Telephone – *CapTel*! With *CapTel*, you can see captions of everything people say over the phone, letting you enjoy calls with confidence.

**Please take a moment to read this guide and learn:**

- How to start using your *CapTel* phone
- How your *CapTel* phone works
- How to get help when you have questions

We want the *CapTel* phone to be enjoyable and convenient for you. As you use your new phone, we welcome your questions and comments. If we can help, please call!

Thanks again for choosing *CapTel*.





Sincerely,

*CapTel* Customer Service

1-888-269-7477

[www.CapTel.com](http://www.CapTel.com)

# T A B L E O F C O N T E N T S

	<b>Overview – How <i>CapTel</i> Works</b> .....	<b>4</b>
	<b>Section 1: Getting Started</b> .....	<b>5</b>
	What is in the box .....	5
	Overview of <i>CapTel</i> 840i phone.....	6
	Using a headset or neckloop (optional).....	11
	Setting up your <i>CapTel</i> 840i .....	12
	Registering your <i>CapTel</i> phone.....	21
	<b>Section 2: Making and Answering Calls</b> .....	<b>23</b>
	Dialing a phone number directly .....	24
	Calling using the Speed Dial buttons.....	25
	Calling a number in the Phone Book .....	26
	Answering an incoming call .....	27
	Adjusting the volume .....	28
	Adjusting the sound – TONE.....	29
	Knowing what sounds are on the line.....	30
	<b>Section 3: Viewing Captions</b> .....	<b>31</b>
	Turning captions on/off during a call.....	32
	Viewing corrections.....	32
	Reviewing captions during a call.....	33
	Reviewing captions after hanging up .....	34
	Saving conversations.....	35
	Erasing all conversations.....	37
	Changing the caption font size.....	38
	Setting the color of the captions .....	40
	Setting how captions scroll across the Display Screen.....	42
	Adjusting the brightness of the Display Screen .....	44
	<b>Section 4: Call History</b> .....	<b>46</b>
	Using Call History to see recent calls.....	47
	Clearing all Caller ID entries.....	49

<b>Section 5: Using the Answering Machine</b> .....	<b>50</b>
Turning Answering Machine on/off .....	51
Playing your Answering Machine messages.....	52
Clearing all messages .....	55
Recording a personal greeting message .....	56
Setting the number of rings before answering.....	58
Making incoming messages audible/silent.....	60
Captioning external Answering Machine messages .....	62
<b>Section 6: Using the Phone Book</b> .....	<b>64</b>
Adding a new contact to your Phone Book .....	65
Dialing a phone number from the Phone Book.....	67
Editing an existing contact in the Phone Book.....	68
Removing a contact from your Phone Book.....	70
<b>Section 7: Using Speed Dial Buttons</b> .....	<b>71</b>
About the Speed Dial buttons .....	71
Saving phone numbers in the Speed Dial buttons .....	72
Editing phone numbers in the Speed Dial buttons .....	73
Dialing with the Speed Dial buttons .....	74
<b>Section 8: Settings</b> .....	<b>75</b>
Setting the Captions button to on/off.....	76
Turning Spanish captions on/off .....	78
Adjusting the volume of the Ringer .....	80
Setting the pitch of the Ringer .....	81
Turning keypad lights on/off.....	82
Saving the captions volume .....	84
Setting your <i>CapTel</i> phone for Tone/Pulse dialing .....	86
Changing the network settings.....	87
Removing saved networks.....	89
Setting the Time and Date .....	90
Using Call Waiting .....	91
Dialing 911 with your <i>CapTel</i> 840i .....	92
Updating your <i>CapTel</i> phone .....	93
<b>Problem Solving</b> .....	<b>94</b>
<b>Care &amp; Maintenance/Safety Instructions</b> .....	<b>97</b>
<b>Index</b> .....	<b>98</b>

# How *CapTel* Works

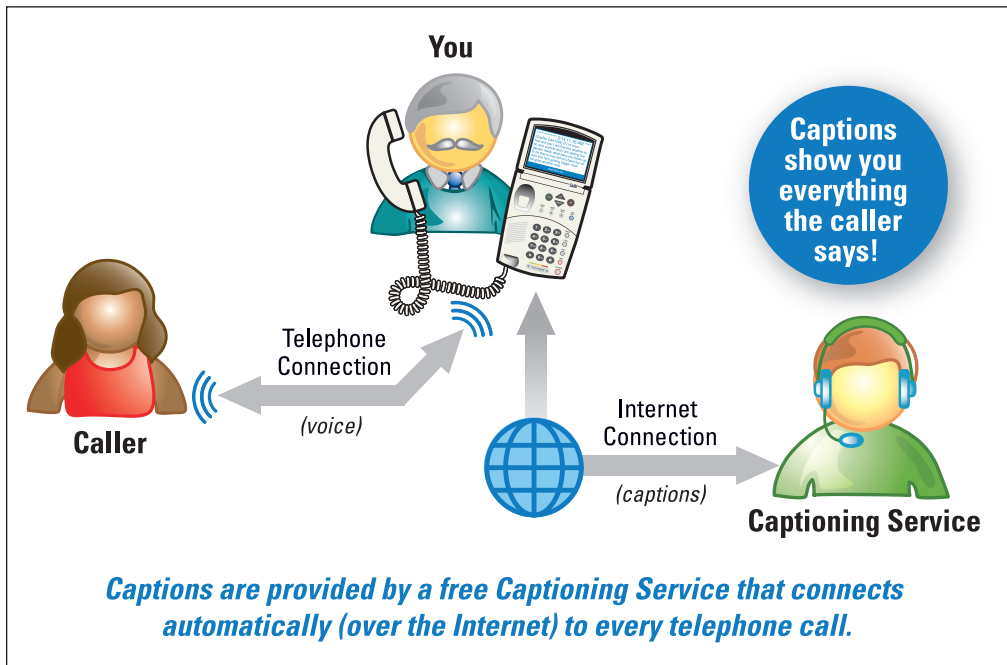

The *CapTel* 840i connects to both your telephone service and to your Internet service. Every time you make a telephone call, the phone uses the Internet connection to access a free Captioning Service. An operator at the Captioning Service uses speech recognition technology to generate captions of everything your caller says, and sends the captions back to your *CapTel* 840i phone.

You can enjoy conversations over the phone with the added help of written captions in case you miss anything.

**NOTE:** *The CapTel 840i phone does not generate captions of the phone call on its own. The phone works with the Captioning Service (over the Internet) to display captions during your calls.*

# Getting Started

*This section explains how to start using your new CapTel 840i phone.*

## TOPICS:

- **What is in the Box**
- **Overview of CapTel 840i Phone**
- **Using a Headset or Neckloop (Optional)**
- **Setting up your CapTel 840i**
- **Registering your CapTel 840i Phone**

## What is in the Box?

Your CapTel 840i includes the following parts:



- CapTel 840i Phone
- Telephone Cord



- Power Adapter – to plug into a wall outlet



*Important! Use only the power adapter that came in the box with your CapTel 840i*

- Ethernet Cable – to connect to Internet service (not necessary for WiFi installations)



- CapTel Setup Guide and CapTel How-to Guide





# Overview of CapTel 840i Phone

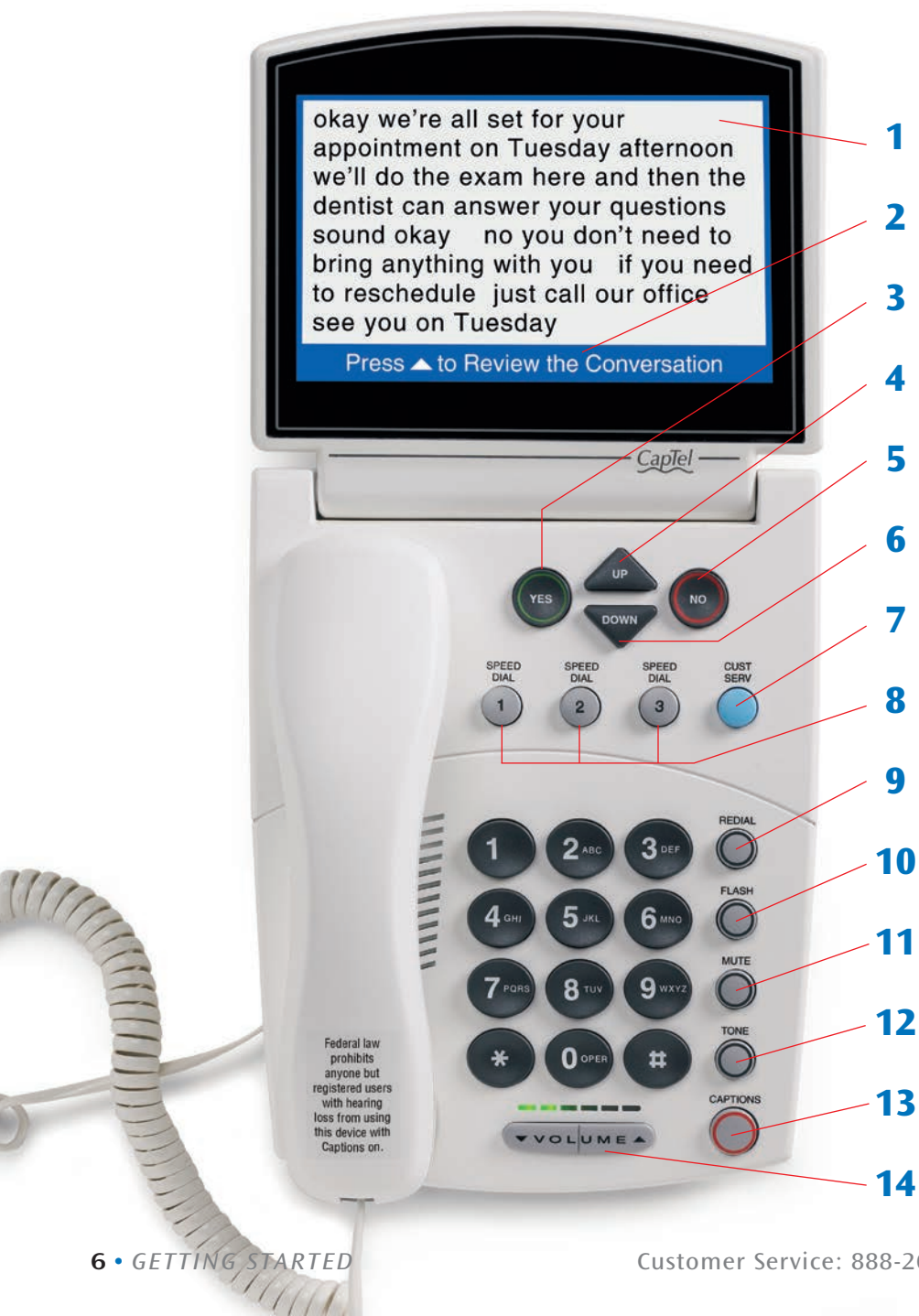



## 1. Display Screen

Shows captions, Caller ID, Answering Machine messages, Phone Book entries and more.

## 2. Information Bar

Gives you instructions and helpful tips.



## 3. YES Button

Allows you to select items that are highlighted in the Options list, and respond “Yes” to questions or commands on the display screen.



## 4. UP Arrow Button

Allows you to move up through items in the Options list and move through entries in your Phone Book, Answering Machine messages, or Call History. Also lets you go back during a call to review captions that have already scrolled off the display screen.



## 5. NO (Exit) Button

Allows you to respond “No” to questions or commands on the display screen and to Exit out of the Options list.



## 6. DOWN Arrow Button

Allows you to move down through items in the Options list and move through entries in your Phone Book, Answering Machine messages, or Call History. Also lets you scroll down through captions when reviewing calls.

CUST  
SERV



## 7. CUSTOMER SERVICE Button

Our helpful customer service team is happy to help you set up and use your *CapTel* 840i telephone – we're only a button push away. Pressing the CUST SERV button will automatically dial the *CapTel* help line. In an office, you may need to dial 9 first.

**NOTE:** *Help is available 24 hours a day, 7 days a week (closed on major holidays). Help materials are also available online at [www.CapTel.com](http://www.CapTel.com)*

SPEED  
DIAL



## 8. SPEED DIAL Buttons

You can quickly dial up to three frequently-called phone numbers, just by pressing a speed dial button.

REDIAL



## 9. REDIAL Button

Lets you dial up to 10 most-recently called phone numbers. Lift the handset and press REDIAL button to dial the last phone number called. Leave the handset down and press the REDIAL button to review/dial up to the last 10 numbers called.

FLASH



## 10. FLASH Button

Some telephone service features like Call Waiting require a “hook flash.” The hook flash is a very brief interruption of the connection like hanging up the phone for one second. There is a brief click or silence on the line.

MUTE



## 11. MUTE Button

Silences the sound from your end of the conversation. When the MUTE button is pressed (red light around the button is ON), the person on the other end of your call will not be able to hear you. You will still be able to hear the caller and get captions of everything they say. To turn the Mute feature off, press the MUTE button again (red light around the button is OFF).

TONE



## 12. TONE Button

Allows you to adjust the sound settings of the call, letting you enhance LOW, MED, or HIGH frequency tones to find the range that you hear best.

CAPTIONS



## 13. CAPTIONS Button

Whenever the red light is on around the CAPTIONS button, your calls will automatically be connected over the Internet to the free Captioning Service, and you will get captions during the call. Captions can be turned on or off at any time. To turn the captions off, just press the CAPTIONS button to turn the red light off.



## 14. VOLUME Bar

Lets you adjust the volume to a comfortable level, up to a 40 dB gain from min/max for captioned calls. To increase the volume, press the ▲ right side of the VOLUME bar. To decrease the volume, press the ▼ left side of the VOLUME bar. There are 12 volume levels. Watch the light panel above the VOLUME bar to know what the current volume setting is.

**WARNING:** *The maximum volume setting on captioned calls is very loud. People who do not need amplification should not use the phone at the highest volume setting. The volume level automatically returns to a mid-range setting whenever the phone is hung up.*

To prevent your CapTel phone from returning to a mid-range volume setting whenever the phone is hung up, see “Saving the Captions Volume” on page 82.

**NOTE:** *Per FCC requirements, your CapTel handset includes a reminder that no one other than the registered CapTel user should use your phone with the Captions feature turned ON. As long as the CAPTIONS button is turned OFF, others are welcome to use your CapTel phone.*

## Back (top) edge view of *CapTel* 840i

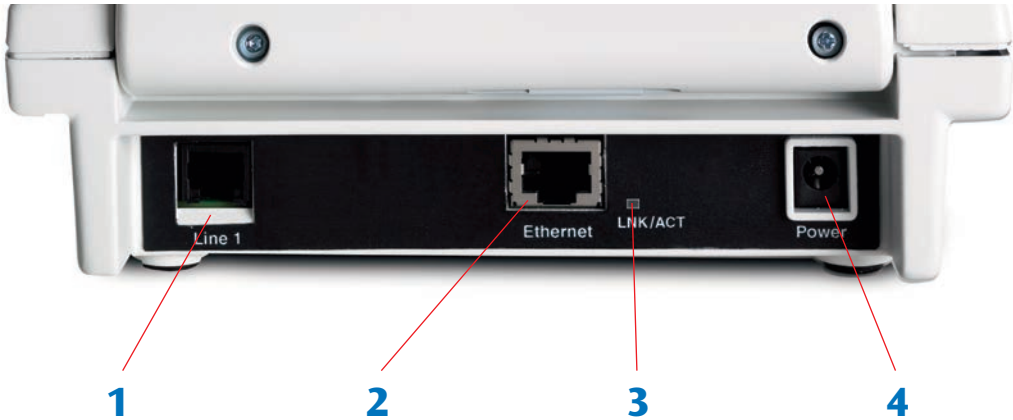

### Features

#### 1. Telephone Line

Plug the telephone cord here (RJ11 jack). Phone cord can be for analog, VOIP, fiber optic, Digital Cable service, or analog with DSL service. *CapTel* 840i should not be used with a PBX system unless an analog port is available, otherwise it will cause damage to the phone or PBX system.

#### 2. Ethernet Jack

Plug the Ethernet cable (provided) here to connect to your Internet Service.

**NOTE:** *If you are connecting to the Internet using a WiFi network, you do not need to connect the Ethernet cable.*

#### 3. Ethernet Status Light

Lets you know if your Ethernet cable is connected to the Internet and whether activity is on the line.

**NOTE:** *The LNK/ACT indicator does not light up when using a WiFi connection.*

#### 4. Power Jack

Plug the AC power adapter here. Use only the AC power adapter that came with your *CapTel* phone.

# Using a Headset or Neckloop (Optional)

---

## Audio Jacks (2.5 mm/3.5 mm)

You can use earphones, a headset, neckloop, or other type of listening device with the *CapTel* 840i to maximize the audio quality or to enjoy your new phone hands-free. Simply plug the headset/assistive device into the appropriate 2.5 mm or 3.5 mm audio jack located on the right edge of the *CapTel* 840i phone. Open the protective cover to reach the jacks.

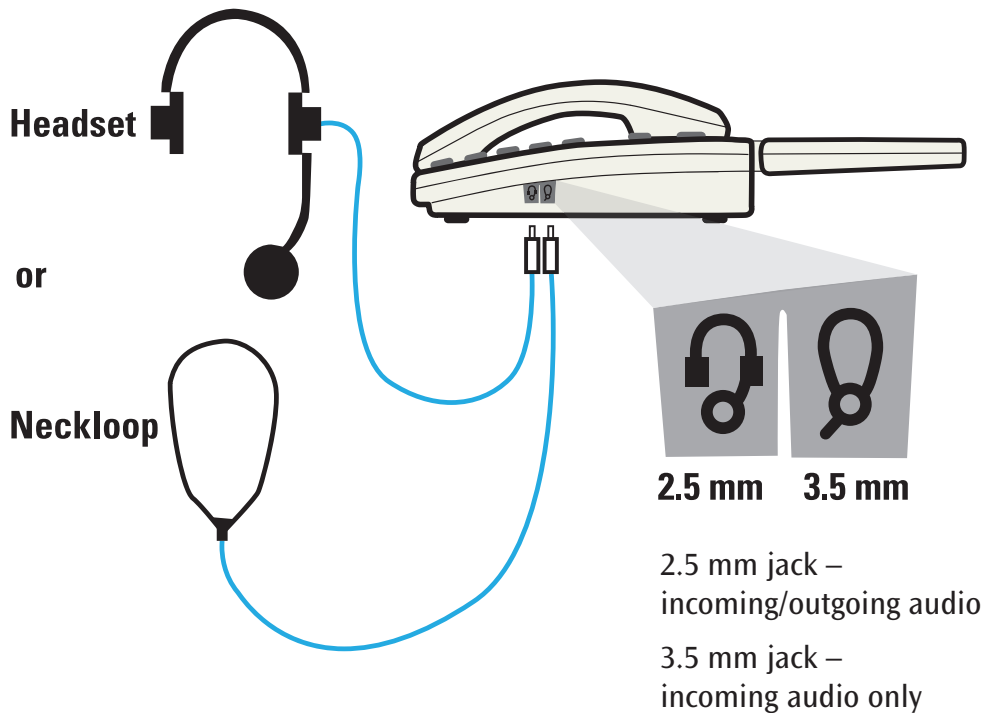

# Setting up Your *CapTel* 840i

---

*For complete instructions, please see the Setup Guide.*

## Requirements

1. High-speed Internet access using a DSL or Digital Cable modem (the *CapTel* 840i connects either via a WiFi network or with an Ethernet cable). Depending on your Internet setup, a router may also be required to allow you to connect more than one device to your Internet service.
2. Telephone service (can be analog line, DSL with filter, VOIP, fiber optic, or Digital Cable phone service). *CapTel* does not work with digital Private Branch Exchange (PBX) systems found in some office environments, residential facilities, and hotels, unless an analog port is available. Using *CapTel* with a PBX system without an analog port may damage the phone and the PBX system.
3. Standard electrical power (AC adapter plugs into standard wall outlet).

## Select a location

### Set up the *CapTel* 840i in a place where:

- There is a high-speed Internet (Ethernet) jack or your wireless router is located nearby.
- There is a telephone jack nearby (can be analog line, DSL with filter, VOIP, fiber optic, or Digital Cable phone service).
- There is an electrical outlet nearby.
- The surface it will be set on, or mounted to, is stable and secure.
- The area is protected from excessive heat or humidity.

**NOTE:** *The outlets for power, the phone line, and the Ethernet connection should all be located nearby, as each cord needs to plug into your CapTel 840i. If your Internet access is located in a different room than where you plan to use the CapTel 840i, a WiFi setup is recommended. Please see the Setup Guide or contact CapTel Customer Service for help setting everything up.*

## Connect to your telephone service

1. Plug one end of the telephone cord into the telephone jack labeled “Line 1” located on the back (top) edge of the *CapTel* 840i. Use the telephone cord included with your new *CapTel* 840i phone.
2. Plug the other end of the telephone cord into a telephone wall outlet.

**NOTE:** *If you need to connect more than one device to the same telephone line, please see “Sharing a Telephone Line Jack” on page 94.*

## Connect to a power outlet

1. Plug the power adapter cord into the socket labeled “Power” located on the back (top) edge of the *CapTel* 840i.
2. Plug the power adapter into a wall outlet or power strip. The *CapTel* display screen will light up to let you know power is connected.

**TIP:** *Plug your power adapter into an electrical power surge protector to protect your CapTel 840i from damage caused by unspecified electrical voltage or damage caused by lightning.*

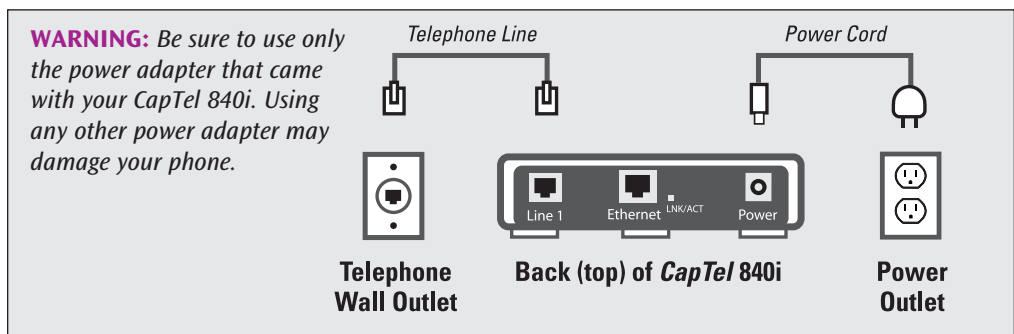

Once you plug in the power, your *CapTel* phone will automatically check that everything is connected and working properly. You can follow along on the *CapTel* display screen, which will tell you what is happening during the setup process.



## Select a Language

You can set the *CapTel* 840i for either English or Spanish language. The *CapTel* menu options and conversation captions will appear in whichever language you select.



1. When the *CapTel* screen lights up, select which language you would like. Press the **UP** arrow or **DOWN** arrow until the language you want is highlighted.



2. Press the **YES** button to accept.

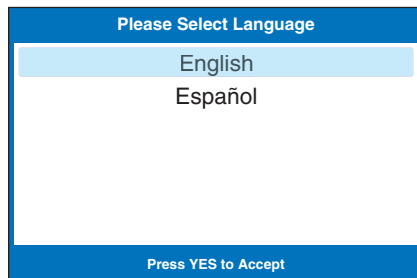

**NOTE:** *You can change the Language setting at a later time. Please see “Turning Spanish Captions On/Off” on page 76.*

## Connect to your Internet service

There are two ways to connect to your Internet service:

**Option 1: Wired** – use an Ethernet cable to connect to the Internet.

Please follow instructions for “Wired Installations” below.

**Option 2: Wireless** – use your home/office WiFi network to reach the Internet. Please follow instructions for “Wireless/WiFi Installations” on page 16.

### For Wired Installations

1. Plug one end of the Ethernet cable into the jack labeled “Ethernet”. Located on the back (top) edge of the *CapTel* 840i. Be sure to use the Ethernet cable that came with your new *CapTel* 840i phone.
2. Connect the other end of the Ethernet cable into the jack you use to access your Internet service.

Depending on how your Internet service is set up for your home/office, you could be plugging into any of the following:

- An available Ethernet jack on a digital cable modem
- An available Ethernet jack on a DSL modem
- An available Ethernet jack on a router in your home
- An available Ethernet jack in a wall outlet

**NOTE:** *When connected properly, LNK/ACT indicator light will glow. The LNK/ACT indicator light is located next to the Ethernet jack on the back (top) edge of the CapTel 840i.*

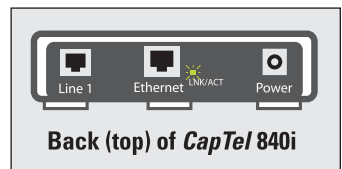

Use the examples on the following pages to match your setting with the correct installation method.

## All Outlets Located Together (Wired Setup)

**Example 1:** All of the connection outlets (*telephone, Internet, and power*) are available in the same room that you are planning to use the *CapTel 840i*.

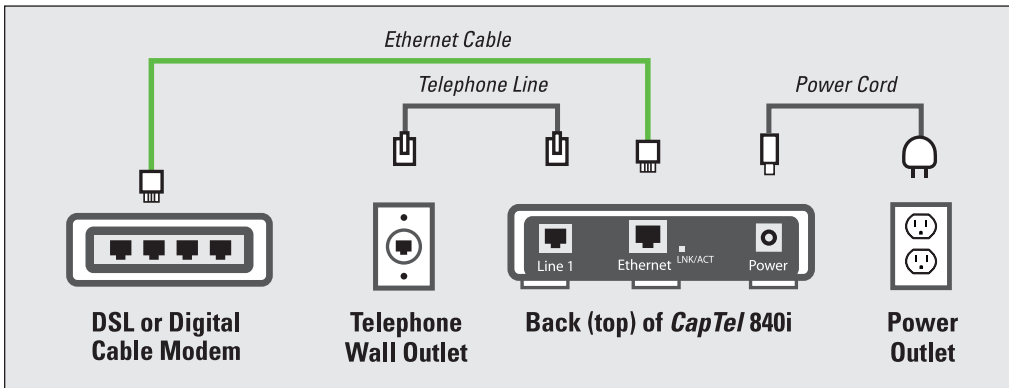

**Example 2:** If there is not an available Ethernet jack in your DSL or Cable Modem, you will need a router or switch that lets you connect more than one device to the Internet. Contact your Internet Service Provider to learn what router or switch will work with your modem. The router should support DHCP. Connect the router to your DSL/Cable Modem. Then connect the *CapTel 840i* to the router or switch *using the Ethernet cable as shown below*.

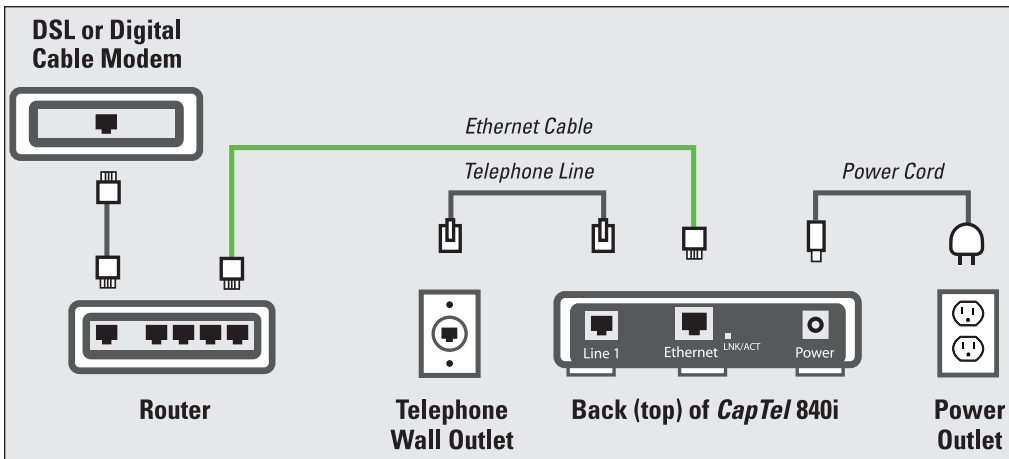

If your Internet outlet is in a different room from where you plan to use *CapTel*, see the Setup Guide for instructions.

## For Wireless/WiFi Installations

If you have a wireless (“WiFi”) network in your home or office, your *CapTel* phone can connect to the Internet using the WiFi network. You do not need to plug in an Ethernet cable.

To set up your *CapTel* for WiFi use, you will need to know the name of your wireless network (*also called the SSID*) as well as any passwords that may be necessary to access the network. The way you access your WiFi network with *CapTel* will be very similar to how you access the network from a computer or mobile device.

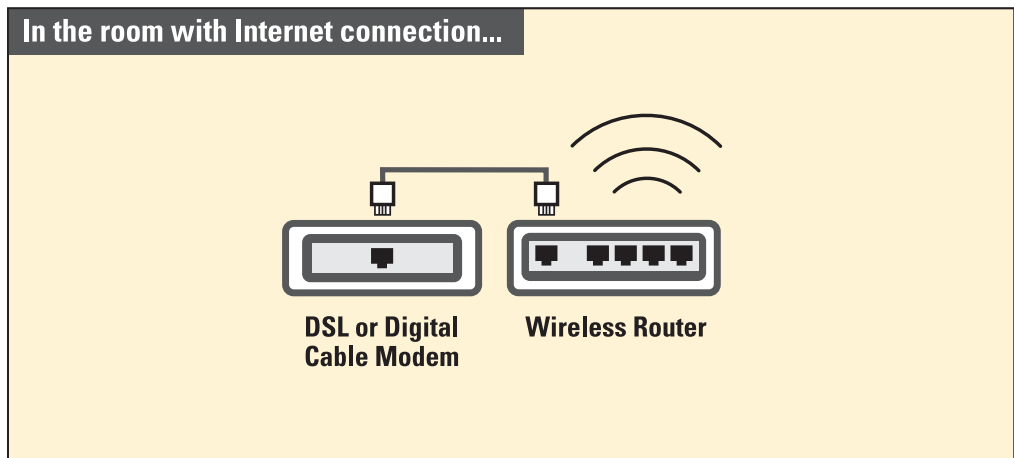
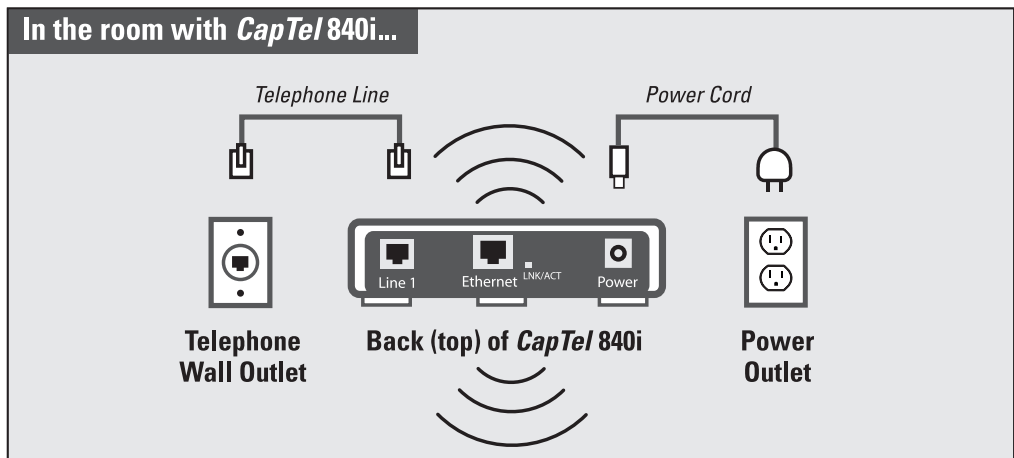

**NOTE:** *If someone helped install the wireless network in your home or office, it may be helpful to consult with them as you set up your CapTel phone.*

To set up your WiFi connection:



1. The display asks, **Press YES for WiFi Setup.** Press the **YES** button.
2. Your *CapTel* checks if any wireless networks have been used previously and are already saved in memory. If no previous networks are detected, *CapTel* scans for available networks in your location.



3. *CapTel* lists any WiFi networks detected, in order of the strongest signal strength to the weakest signal strength. Use the **UP/DOWN** arrows to highlight the wireless network you want to use. Press the **YES** button to select.

**NOTE:** *CapTel may detect wireless networks in your location that you do not recognize – such as a wireless network from a neighbor or nearby office. Be sure to select the SSID that matches your WiFi network.*

If you do not see the network you want listed, try moving your *CapTel* phone to an area closer to your wireless router and selecting “Refresh Network List”. *CapTel* will re-scan for available networks. See the Setup Guide for additional directions.

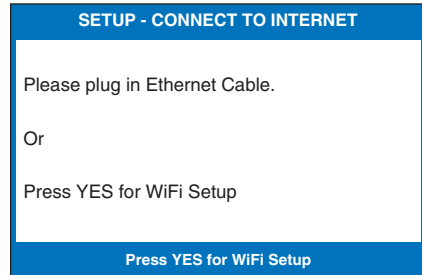

SSID	Security	Ch.	Signal
2WIRE269	WPA	08	
OfficeNet	WPA	06	
ACBRDBAND	WPA	06	
NETWORK1	WPA	04	
Refresh Network List			
Enter Network Manually			

Press YES to Select a Wireless Network  
Press NO to exit WiFi Setup

4. If required, *CapTel* asks for the password to access your WiFi network.

**NOTE:** *Where to find your WiFi password? This is the same password you need to access the WiFi network from any computer or mobile device. The password (sometimes called a “pass phrase” or “network key”) is assigned by your Internet Service Provider or by whomever set up your wireless network. In some cases, the password may be listed directly on your wireless router.*

Use the dialing pad to enter the letters or numbers of your password. Look for the letters listed on the number keys to know which number key to press. For some letters/numbers, you will need to press the number key several times until the correct letter/number appears on the display screen. For special characters (i.e., %, &, #) press the 1 key repeatedly.

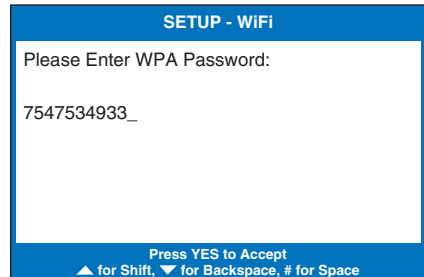

**TIP:** *Some passwords are case-sensitive. Press the UP arrow button to shift lock for capital letters. Press the UP arrow button again to return to lower case.*

**Example:** To enter the letter “R”, press the UP arrow key to set shift-lock to capital letters, then press the number 7 key three times until you see “R” on the display screen.

**NOTE:** *Depending on the type of security on your wireless network, you may not be asked to enter a password.*

**TIP:** *After you have typed your password, double-check that you have all the letters and numbers listed correctly, and that any capital/lower case letters are entered properly. If the password is not correct, *CapTel* will not be able to connect to your WiFi network.*



5. After you have entered the password, press the **YES** button to accept. *CapTel* will save your network settings, and connect to your wireless network.

**NOTE:** Once your CapTel phone connects to the Internet, it automatically checks to make sure that you have the most current software version. If needed, your phone will automatically update its software over the Internet connection. Watch the display screen to follow the progress. Your CapTel phone may reboot as part of the update process. Once the entire process is completed, you will be able to continue with the installation.

## Set Time and Date



1. CapTel shows you the current time and date setting. To change it, use the **UP** or **DOWN** arrow buttons to move the blue highlight over the number that you want to change.

2. On the dialing pad, press the key that lists the number you want to use.

**Example:** To set the time for 11:30, press the “1” key twice, then press the “3” key followed by the “0” key.

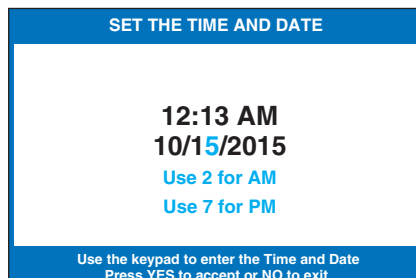
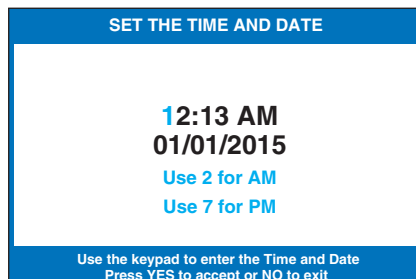

**TIP:** To change the time from AM to PM, make sure the AM/PM section is highlighted, then press the 2 key for “AM” and the 7 key for “PM”.

**NOTE:** When you enter the date setting, only the last two numbers in the year can be changed.

3. When you have set the time and date, press the **YES** key to save.



# Registering Your CapTel Phone

The first time that you set up your *CapTel* 840i, you will be asked to register your phone and agree to the Terms & Conditions for using *CapTel*. Registration is required by the FCC before the Captions feature can be activated.

Once you complete this step, you will not need to register again, even if you move your phone to a new location.

**NOTE:** *If your phone display shows different directions than the instructions below, please follow the directions on your CapTel phone display screen to complete your registration.*

To register:

In some cases, the display screen may ask you to register your *CapTel* phone by going online or calling *CapTel* Customer Service. Follow the directions on the screen to register.

Register online at: [www.CapTel.com/register](http://www.CapTel.com/register)

CUST  
SERV



Or, press the blue **Customer Service** button to reach an Installation Help Specialist.

CAPTIONS



Once you've registered, press the **CAPTIONS** button to clear the registration screen and continue.

1. The display screen alerts you that you should read and agree to the Terms & Conditions for using *CapTel*.
2. The display screen lists the Terms & Conditions for using the *CapTel* phone.

Please register your phone at [www.CapTel.com](http://www.CapTel.com) or Contact CapTel Customer Service.

After registering your ESN (424C5500146) press the CAPTIONS button to continue.

Press YES for Options

\*\*\*\*\* Terms & Conditions \*\*\*\*\*

Before using the CAPTIONS feature, please register your phone at [www.CapTel.com](http://www.CapTel.com) or Contact CapTel Customer Service.

This phone's ESN is 424C5500146

Press NO to exit

Before using CAPTIONS feature, please read and agree to the following Terms & Conditions

Downloading – Please Hold



3. Follow the directions on the display screen to review each of the Terms & Conditions. Press the **YES** button to accept each statement.

Once you've agreed to all the Terms & Conditions, the process is complete. Congratulations! You can begin making and answering calls with captions.

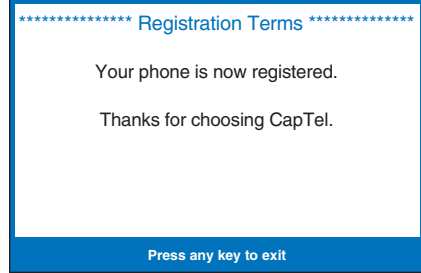
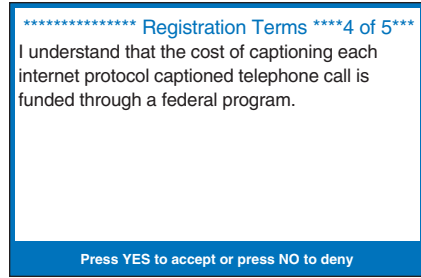

If you do not agree with the Terms & Conditions, press the **NO** button. The CAPTIONS feature will remain off during your calls. You can still use *CapTel* as a standard telephone, but you will not receive captions during your calls.

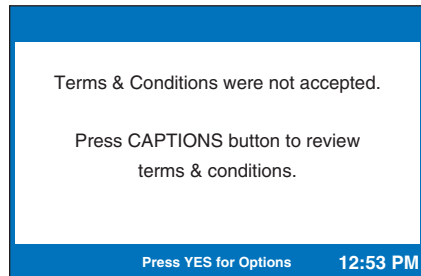

Captions will not be activated on your phone until the Terms & Conditions are accepted.

CAPTIONS



To review the Terms & Conditions wording again, press the **CAPTIONS** button. The Terms & Conditions information will appear again, and you will have another opportunity to accept the Terms & Conditions by pressing the **YES** button.

CUST  
SERV



If you have any questions about the Terms & Conditions or how to register your *CapTel* phone, please press the blue **Customer Service** button for assistance.

# Making and Answering Calls

*This section explains how to place outgoing calls and how to answer incoming calls with your CapTel 840i.*

## TOPICS:

- **Dialing a Phone Number Directly**
- **Calling Using the Speed Dial Buttons**
- **Calling a Number in the Phone Book**
- **Answering an Incoming Call**
- **Adjusting the Volume**
- **Adjusting the Sound – TONE**
- **Knowing What Sounds are on the Line**

# Dialing a Phone Number Directly

## CAPTIONS



1. Lift the handset.
2. Make sure the **CAPTIONS** button is on (red light on). You can turn captions on/off at any time during your call by pressing the **CAPTIONS** button.
3. Dial the phone number of the person you wish to call.

**NOTE:** *If you need to dial a 9 or other number to get an “outside” line, enter that number first, then dial the phone number.*

4. As you dial, the display screen shows the status as your *CapTel* phone connects to the captioning service, letting you know when captions are ready.

**NOTE:** *It is okay if the captioning service connects before you finish dialing the phone number, just keep dialing.*

5. Listen or watch the signal meter to know when someone answers. Watch the display screen for captions. Begin your conversation as you normally would.

When you are done with your call, hang up the handset.

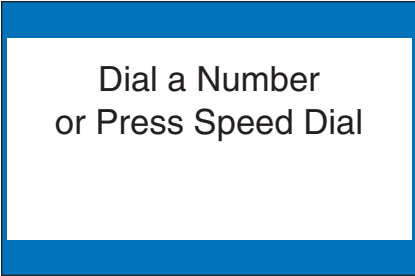

Dial a Number  
or Press Speed Dial



Dialing:  
555

Waiting for Captions  
Stage 7 of 8

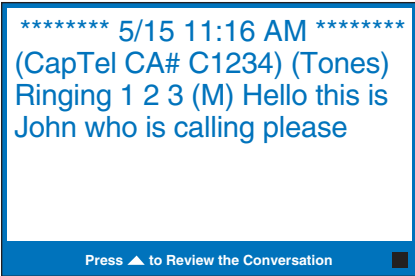

\*\*\*\*\* 5/15 11:16 AM \*\*\*\*\*  
(CapTel CA# C1234) (Tones)  
Ringing 1 2 3 (M) Hello this is  
John who is calling please

Press ▲ to Review the Conversation

**TIP:** *Remember to dial 1+ area code if the number you are calling is long distance.*

# Calling Using the Speed Dial Buttons

**NOTE:** You must save telephone numbers in the Speed Dial buttons before they can be used to dial. Please see page 71 for directions.

CAPTIONS



1. Make sure the **CAPTIONS** button is on (red light on).

SPEED DIAL



2. Press the **SPEED DIAL** button with the number that you want to call.

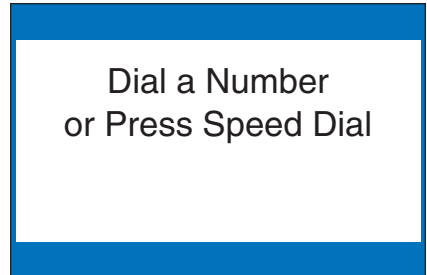

3. Lift the handset. Your *CapTel* phone will dial the phone number for you automatically. As you dial, the display screen shows the status as your *CapTel* phone connects to the captioning service, letting you know when captions are ready.

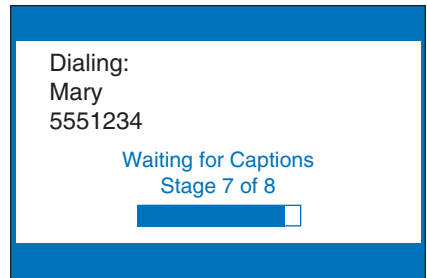

4. Listen or watch the signal meter to know when someone answers. Watch the display screen for captions. Begin your conversation as you normally would.

When you are done with your call, hang up the handset.

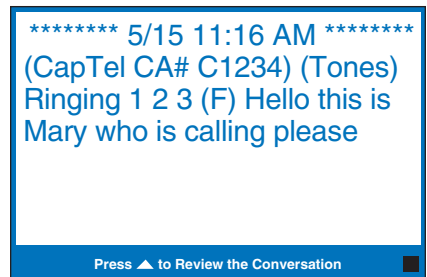

↑  
Signal Meter

# Calling a Number in the Phone Book

**NOTE:** Phone numbers must already be saved in the Phone Book before you can use the Phone Book to dial. Please see page 65 for directions.

CAPTIONS



1. Make sure the **CAPTIONS** button is on (red light on).



2. With the handset hung up, press the **YES** button to see the Options menu.



3. Check that **Dial from Phone Book** is highlighted. Press the **YES** button to select.



4. Press the **UP** arrow or **DOWN** arrow buttons to find the person you want to call.

5. Pick up the handset. Your *CapTel* phone dials the number for you automatically.

6. Listen or watch the signal meter to know when someone answers. Watch the display screen for captions. Begin your conversation as you normally would.

When you are done with your call, hang up the handset.

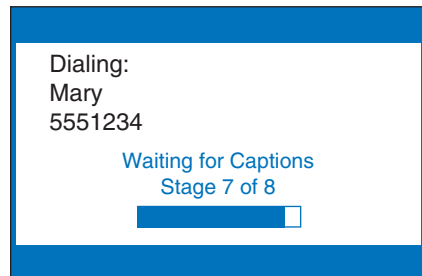
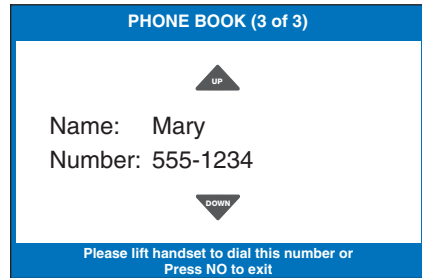
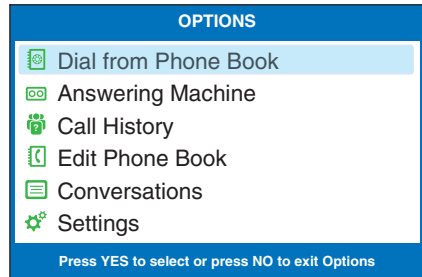

# Answering an Incoming Call

1. When your *CapTel* phone rings, the display will light up to alert you to an incoming call.

**NOTE:** *If you have Caller ID service, you will see the name and/or the phone number of the person calling.*



CAPTIONS



2. Make sure the **CAPTIONS** button is on (red light on).
3. Pick up the handset, and answer the call as you normally would.
4. Listen or watch the signal meter for a response. Watch the display screen for captions.

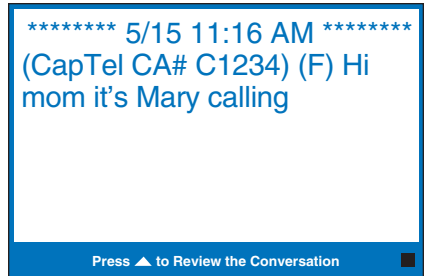

**TIP:** *If you answer on an extension telephone and want to get captions, just pick up the CapTel handset and press any of the number keys. Your CapTel phone will connect to the Captioning Service, and you will be able to view captions of the call on the CapTel display screen.*



# Adjusting the Volume

---

You can increase the volume of the person's voice coming through the handset, up to a 40 dB gain from min/max on captioned calls (when the **CAPTIONS** button is off, the maximum amplification is 18 dB gain). Watch the lights above the **VOLUME** bar to see what level the volume is set to.



To increase the volume (make sounds louder) during a call, press the ▲ right side of the **VOLUME** bar.

To decrease the volume (make sounds softer) during a call, press the ▼ left side of the **VOLUME** bar.

**WARNING:** *The maximum volume setting on captioned calls is very loud. People who do not need amplification should not use the phone at its highest volume setting. The volume level automatically returns to a mid-range setting whenever the phone is hung up.*

To save your volume setting so that it will be used during every captioned call, see Saving the Captions Volume on page 82.

# Adjusting the Sound – TONE

You can adjust the Tone setting to a frequency range that works best for your hearing level – to emphasize HIGH, MEDIUM, or LOW frequency sounds. The Tone setting can be adjusted during, before, or after a call. The setting will remain in effect until you change it again.

**TONE**  If you hear low-frequency tones better, press the **TONE** button repeatedly until you see “Tone is Low” on the display screen.

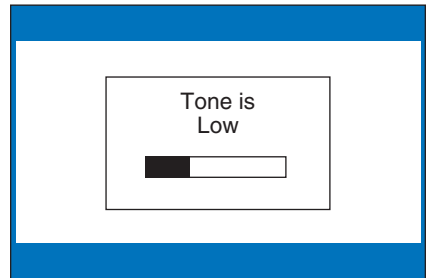

**TONE**  If you hear mid-range frequency tones better, press the **TONE** button repeatedly until you see “Tone is Medium” on the display screen.

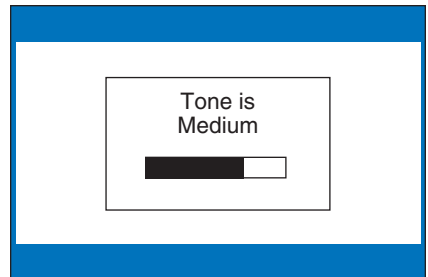

**TONE**  If you hear high-frequency tones better, press the **TONE** button repeatedly until you see “Tone is High” on the display screen.

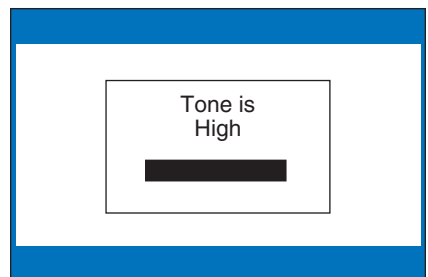

**NOTE:** *You can also use a headset or neckloop to enhance the sound quality. Please see page 11 for instructions.*

# Knowing What Sounds Are on the Line

The display screen tells you what sounds are occurring during your call with two visual indicators: the Signal meter and the Outgoing Volume meter. These meters only appear during captioned calls.

## The Signal Meter

This helpful meter lights up to indicate sounds on the handset, such as the caller's voice or a busy signal. It shows whenever a sound is coming through the handset, even if the sound is not loud enough for you to hear. The size of this meter expands and contracts with the volume of the sound. Very loud sounds cause the meter to completely light up the whole box. Quiet sounds may cause just a single dot on the display to light up. This meter can help you gauge when a person is finished speaking or initially answers a call.

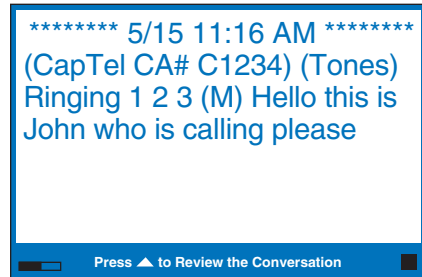

↑  
**Signal  
Meter**

## The Outgoing Volume Meter

This meter helps you see how loudly you are speaking. More of the bar lights up if you speak loudly. Less of the bar lights up if you speak quietly. You can use the volume meter to gauge the volume of your own voice during a call.

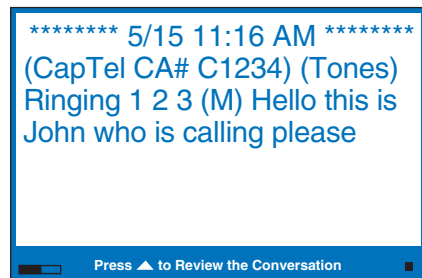

↑  
**Outgoing  
Volume  
Meter**

**NOTE:** *If the Outgoing Volume Meter is filling completely or consistently turns red, you may be speaking too loudly or are holding the telephone handset too close to your mouth.*

# Viewing Captions

*This section explains how to adjust and review conversation captions.*

## TOPICS:

- **Turning Captions On/Off During a Call**
- **Viewing Corrections**
- **Reviewing Captions During a Call**
- **Reviewing Captions After Hanging Up**
- **Saving Conversations**
- **Erasing All Conversations**
- **Changing the Caption Font Size**
- **Setting the Color of the Captions**
- **Setting how Captions Scroll Across the Display Screen**
- **Adjusting the Brightness of the Display Screen**

# Turning Captions On/Off During a Call

**CAPTIONS** You can turn captions on at any time during your call by pressing the **CAPTIONS** button. When the red light around the **CAPTIONS** button is lit, you will see captions of everything the other party says. When the light is off, you will not receive captions.



**CAPTIONS** If you turn captions on in the middle of a call, there will be a brief delay as your *CapTel* 840i phone connects to the Captioning Service. Then, captions will begin. During this time, you may still talk/listen to the other party. You do not need to wait for captions to begin if you can hear the other party well enough to carry on the conversation. You can speak at any time even if captions are not present.

## Viewing Corrections

On occasion, word errors may appear in the captions due to the voice recognition system the Captioning Service uses. The Captioning Service will try to correct any word errors as they occur. The corrected word appears in [brackets] to let you know a correction has been made.

There may be a slight delay before the word error is corrected. If you are unclear about what was said, ask your caller to clarify.

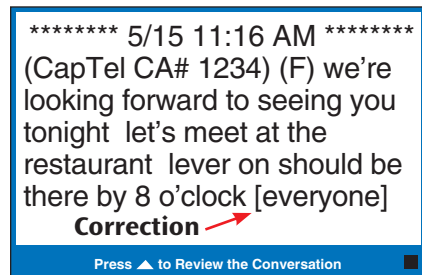
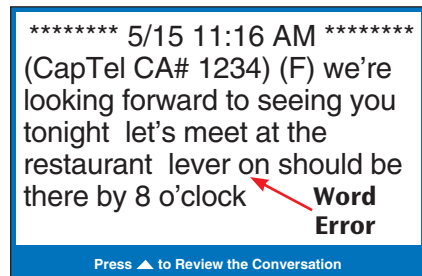

# Reviewing Captions During a Call

---



While on a call, press the **UP** arrow button to scroll back through captions that appeared earlier in the conversation. You can continue talking or listening while you review captions. Everything the other party says will continue to be captioned, even while you are looking back at earlier captions.

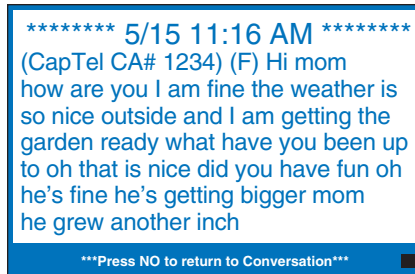

When you are ready to return to the live conversation captions, press the **NO** button. Anything the other party said during the time you were reviewing captions will appear, and the live captions will continue as usual.

You can go back, again, at any time during the call to review what was said. Just press the **UP** arrow button.

**NOTE:** *Your CapTel phone holds up to 500 lines of captions in conversation memory. If the conversation memory fills up entirely, older captions will be erased as new captions come in.*

# Reviewing Captions After Hanging Up

To review captions after your conversation is ended and the phone is hung up:



1. With the handset hung up, press the **YES** button to see the Options menu.



2. Press the **DOWN** arrow button repeatedly until **Conversations** is highlighted. Press the **YES** button to select.

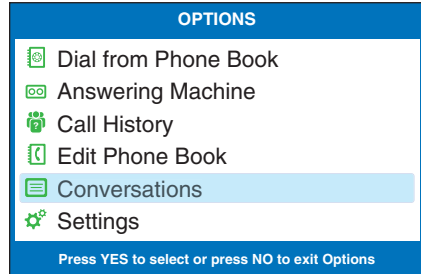

3. Check that **Review** **Conversations** is highlighted. Press the **YES** button to select. You will see captions of your conversations, with the most recent call on the bottom of the screen. Previous conversations may appear further up the display screen.

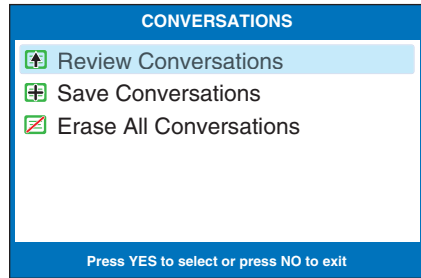

4. Press **UP** or **DOWN** arrow button to scroll through the saved conversations.



5. When you are done, press **NO** to exit.



6. Press the **NO** button repeatedly to exit out of the menu system.

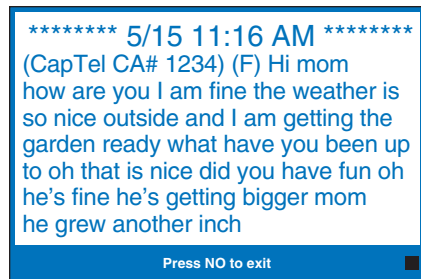

**NOTE:** Your CapTel phone comes with the Save Conversations feature enabled, letting you view conversation captions after you've hung up the phone. To turn off this feature, please see page 35. If you turn off the Save Conversations feature, all conversation captions will be erased every time you hang up the phone.



# Saving Conversations

You can set your *CapTel* phone to Save Conversations after the call has ended and the phone is hung up. This allows you to go back and review what was said after you've hung up. You can review up to 500 lines of conversation captions. Or, you can have captions erased every time the phone is hung up. The default setting is to Save Conversations after the call is ended.

To change the Save Conversations setting:



1. With the handset hung up, press the **YES** button to see the Options menu.



2. Press the **DOWN** arrow button repeatedly until **Conversations** is highlighted. Press the **YES** button to select.



3. Press the **DOWN** arrow button until **Save Conversations** is highlighted. Press the **YES** button to select.



4. Press **UP** or **DOWN** arrow button to turn **SAVE CONVERSATIONS** on or off.

**Save Conversations On** saves conversation captions after the call is finished and the phone is hung up.

**Save Conversations Off** erases the conversation captions after every call.

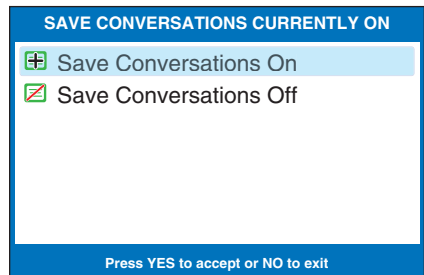
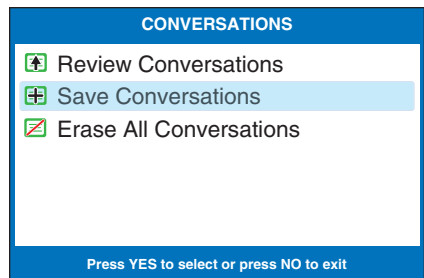
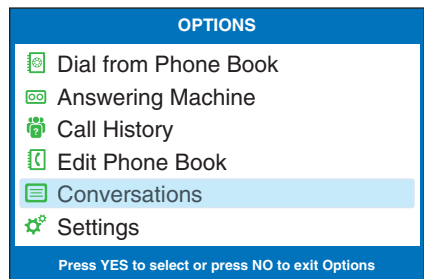



5. After you've made your selection, press the **YES** button to accept or the **NO** button to exit out of Conversation Options.



6. Press the **NO** button repeatedly to exit out of the menu system.

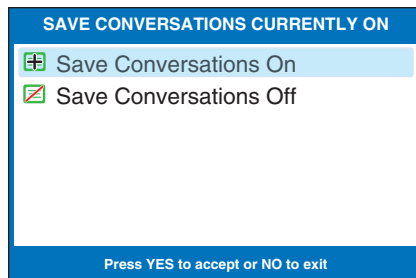

**NOTE:** *This setting will remain On/Off until you change it again.*

**NOTE:** *Your CapTel phone holds up to 500 lines of captions in conversation memory. If the conversation memory fills up entirely, older captions will be erased as newer captions come in. If the power is interrupted to your CapTel phone, conversations stored in memory will be erased.*

# Erasing All Conversations

You can erase all conversation captions stored in memory. To delete your saved conversations:



1. With the handset hung up, press the **YES** button to see the Options menu.



2. Press the **DOWN** arrow button repeatedly until **Conversations** is highlighted. Press the **YES** button to accept.



3. Press the **DOWN** arrow button until **Erase All Conversations** is highlighted. Press the **YES** button to accept.



4. The display screen asks **Would You Like to Erase All Conversations?** Press the **YES** button to erase captions. Or, press the **NO** button to exit.



5. Press the **NO** button repeatedly to exit out of the menu system.

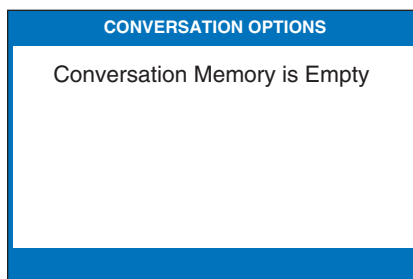
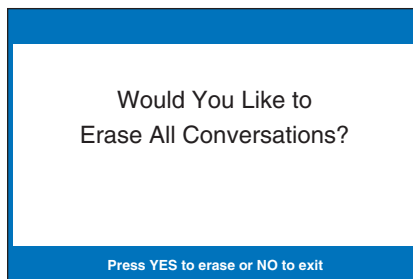
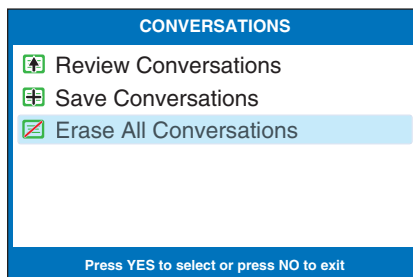
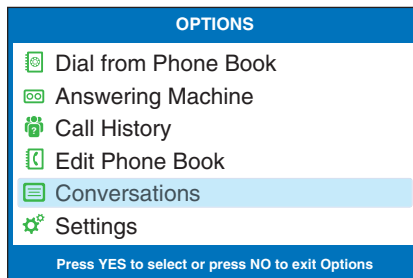

# Changing the Caption Font Size

You can adjust the font size of the conversation captions to be larger or smaller, making the captions easier to read. You need to change the font size before or after a call; you cannot change the font size during a live captioned call.

**NOTE:** *Changing the font size applies only to conversation captions. The font size and style for your CapTel 840i Options menu always remains the same.*

To change the caption font size:

1. With the handset hung up, press the **YES** button to see the Options menu.
2. Press the **DOWN** arrow button repeatedly until **Settings** is highlighted. Press the **YES** button to select.
3. Press the **DOWN** arrow button repeatedly until **Display Settings** is highlighted. Press the **YES** button to select.
4. Press the **DOWN** arrow button until **Set Conversation Font Size** is highlighted. Press the **YES** button to select.

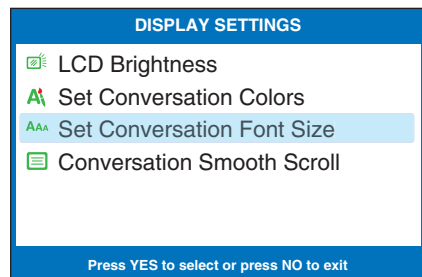
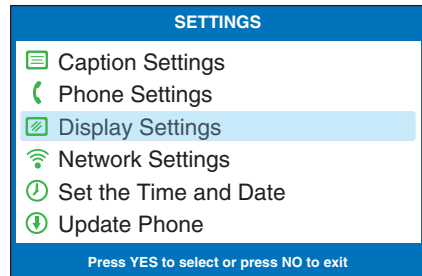
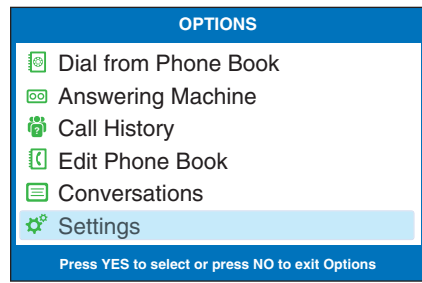

5. The display screen shows what the current font size setting is.



6. Press **UP** or **DOWN** arrow buttons to select the font size you want: SMALL, MEDIUM, LARGE or EXTRA LARGE.



7. Once you've selected the font size, press the **YES** button to accept or press the **NO** button to exit.



8. Press the **NO** button repeatedly to exit out of the menu system.



**NOTE:** *You need to adjust/select the caption font size before or after a call. You cannot adjust the caption font size during a live call.*

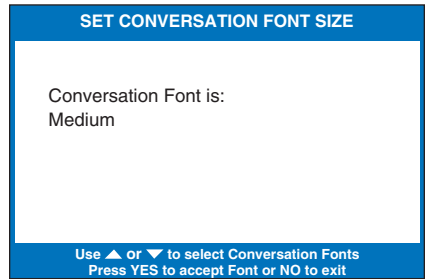
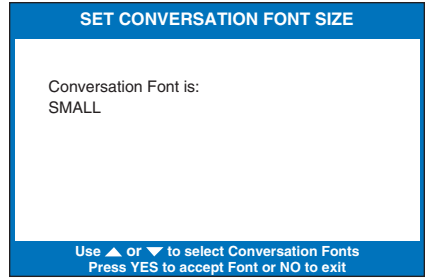

**WARNING:** *Changing the font size will delete all previously saved conversations.*

# Setting the Color of the Captions

You can change the color of the caption font and the background color on the display screen to a color combination that you prefer. You need to set the conversation colors before or after a call. You cannot change the caption colors during a live captioned call.

**NOTE:** *Changing the font colors applies only to conversation captions. The font size and style for your CapTel 840i menu options always remains the same.*

To change the caption font or background colors:



1. With the handset hung up, press the **YES** button to see the Options menu.



2. Press the **DOWN** arrow button repeatedly until **Settings** is highlighted. Press the **YES** button to select.



3. Press the **DOWN** arrow button repeatedly until **Display Settings** is highlighted. Press the **YES** button to select.



4. Press the **DOWN** arrow button repeatedly until **Set Conversation Colors** is highlighted. Press the **YES** button to select.

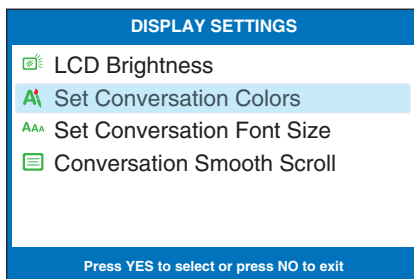
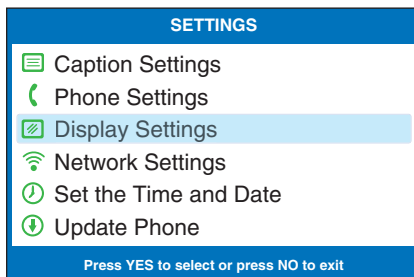
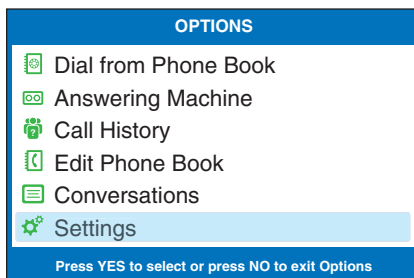



5. The display screen shows what the current text color and background color are set to, with an ▶ pointing toward the **Text Color** setting. Press the **YES** button to select **Text Color**.



6. A color palette appears on the bottom of the display. Use the **UP** and **DOWN** arrow keys to move through the various font color choices. When you find a font color you prefer, press the **YES** button to accept.

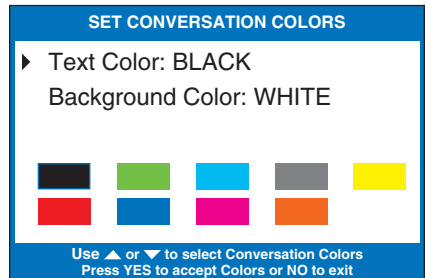

7. The display ▶ moves down to indicate **Background Color**. Press the **UP** and **DOWN** arrow keys to move through the various background color choices. When you find a background color you prefer, press the **YES** button to accept.

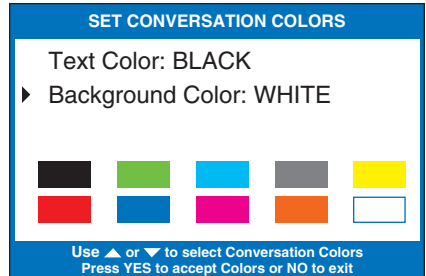

8. Press the **NO** button repeatedly to exit out of the menu system.



**NOTE:** *Whichever color you select for text will not be available as a background color choice.*

# Setting How Captions Scroll Across the Display Screen

You can control how the captions appear on your display screen: either appearing word-by-word as each word is captioned or by scrolling line-by-line in a continuous movement. The default setting is word-by-word. To turn on scrolling:



1. With the handset hung up, press the **YES** button to see the Options menu.



2. Press the **DOWN** arrow button repeatedly until **Settings** is highlighted. Press the **YES** button to select.



3. Press the **DOWN** arrow button repeatedly until **Display Settings** is highlighted. Press the **YES** button to select.



4. Press the **DOWN** arrow button repeatedly until **Conversation Smooth Scroll** is highlighted. Press the **YES** button to select.

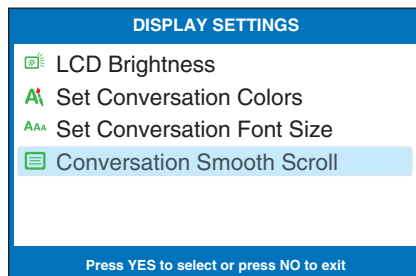
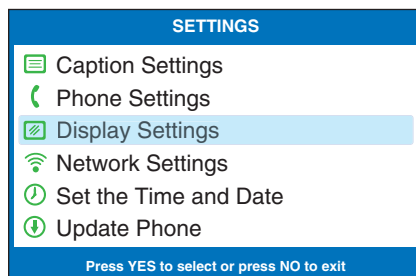
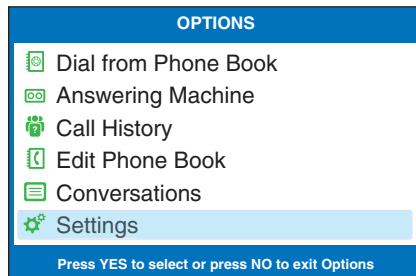





5. Press the **UP** or **DOWN** arrow button to highlight CONVERSATION SMOOTH SCROLL on or off.

**Conversation Smooth Scroll On** rolls captions across the display screen line-by-line in a continuous movement.

**Conversation Smooth Scroll Off** displays captions word-by-word as each word is captioned.



6. After making your selection, press the **YES** button to accept or press the **NO** button to exit.



7. Press the **NO** button repeatedly to exit out of the menu system.

**NOTE:** *This setting will remain On/Off until you change it again.*

# Adjusting the Brightness of the Display Screen

You can adjust the brightness of your *CapTel* 840i display screen to make it easier to read in well-lit or dimly-lit environments.

**NOTE:** You need to adjust the brightness of the Display Screen before or after a call. You cannot set the display screen brightness during a live captioned call.

To adjust the brightness of the Display Screen:

 1. With the handset hung up, press the **YES** button to see the Options menu.

 2. Press the **DOWN** arrow button repeatedly until **Settings** is highlighted. Press the **YES** button to select.

 3. Press the **DOWN** arrow button repeatedly until **Display Settings** is highlighted. Press the **YES** button to select.

 4. Check that **LCD Brightness** is highlighted. Press the **YES** button to select.



 4. Check that **LCD Brightness** is highlighted. Press the **YES** button to select.



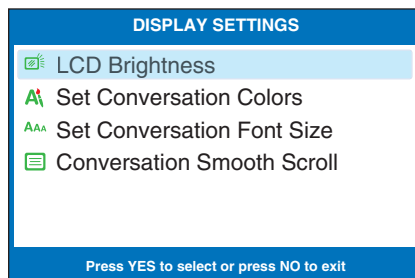
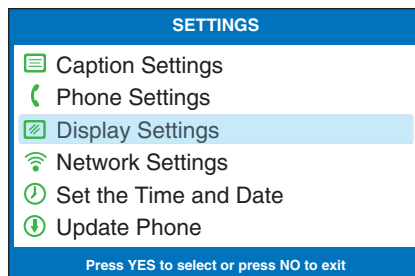
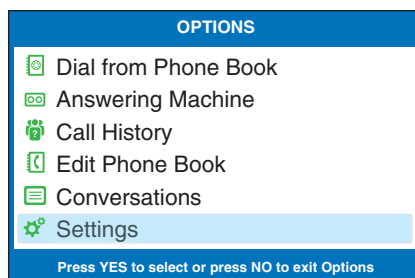



5. The display screen shows what the current brightness level is set to: Minimum, Medium, or Maximum. Use the **UP** and **DOWN** arrows to highlight the level of brightness you would like. Press the **YES** button to select.

**NOTE:** *The display screen will change brightness levels as you select the options.*



6. Press the **NO** button repeatedly to exit out of the Options menu.

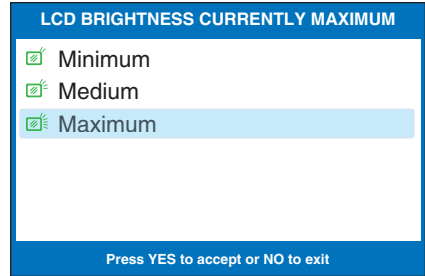

# Call History

*This section explains how to use Call History to see who has called you and to see any incoming calls that you may have missed.*

## TOPICS:

- **Using Call History to See Recent Calls**
- **Clearing All Caller ID Entries**

**NOTE:** *Call History requires Caller ID service from your phone company. If your phone service does not include Caller ID, you will not be able to view Call History with your CapTel 840i.*

# Using Call History to See Recent Calls

Your *CapTel* 840i phone keeps a list of the most recent incoming phone calls, including calls you may have missed. Your *CapTel* phone stores Call History information for up to 99 incoming phone calls.

The *CapTel* display screen automatically shows you the phone number of the person who called you most recently, even if you were not there to answer the call. Depending on your Caller ID service, the display screen may also list the name of the caller. To see other callers' information saved in **Call History**, press the DOWN arrow button to scroll back through recently received calls.

## Missed Calls

Any unanswered calls appear as New Calls in the display screen.



1. To review calls, press the **DOWN** arrow button.



2. Use the **UP** and **DOWN** arrow buttons to move backwards and forwards through previous call listings.

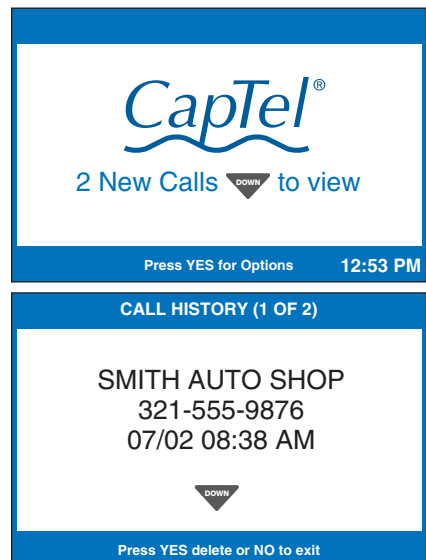

# Previous Calls

You can review Call History information from previous calls at any time. To review recent calls in Call History:



1. With the handset hung up press the **YES** button to see the Options menu.



2. Press the **DOWN** arrow button repeatedly until **Call History** is highlighted. Press the **YES** button to accept.



3. The *CapTel* display screen will show you a list of phone numbers of calls to your *CapTel* 840i, listing the most recent call first and going back in chronological order.



4. Use the **UP** and **DOWN** arrow buttons to move backward and forwards through previous call listings.

**NOTE:** *You can delete Caller ID entries as you review them by pressing the YES button.*



5. When you are done, press the **NO** button repeatedly to exit out of Call History.

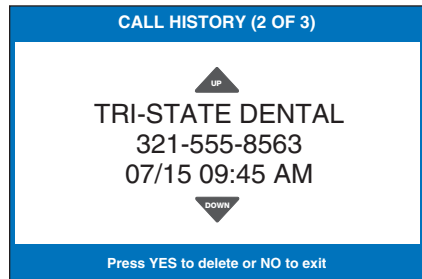
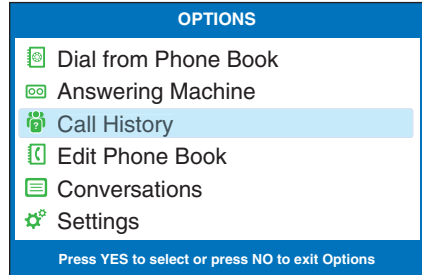

# Clearing All Caller ID Entries

You can delete individual Caller ID entries as you review them (see page 48) or you can erase all Caller ID records at one time.

To clear (delete) all Caller ID entries at one time:



1. With the handset hung up, press the **YES** button to see the Options menu.



2. Press the **DOWN** arrow button repeatedly until **Call History** is highlighted. Press the **YES** button to select.



3. Use the **DOWN** arrow button to highlight **Clear All Caller ID Records**. Press the **YES** button to select.



4. The display asks **Would You Like to Clear All Caller ID?** Press **YES** to erase all Caller ID listings.



5. Press the **NO** button repeatedly to exit out of the Options menu.

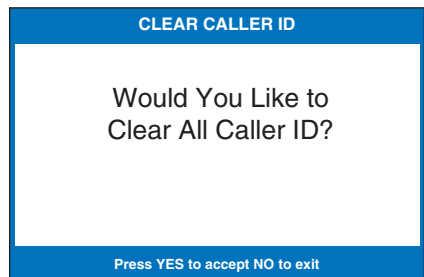
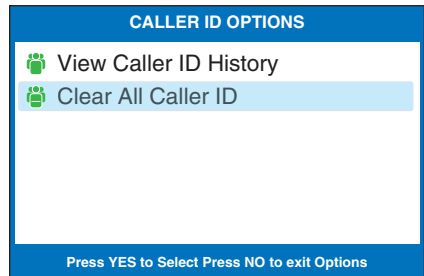
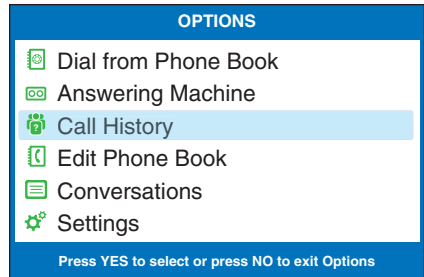

# Using the Answering Machine

*This section explains how to use the built-in Answering Machine to see messages that people leave for you. You can hear the voice recording and press the CAPTIONS button to read captions of the message.*

## TOPICS:

- **Turning Answering Machine On/Off**
- **Playing Your Answering Machine Messages**
- **Clearing All Messages**
- **Recording a Personal Greeting Message**
- **Setting the Number of Rings Before Answering**
- **Making Incoming Messages Audible/Silent**
- **Captioning External Answering Machine Messages**



# Turning Answering Machine On/Off

Your *CapTel* phone comes with a built-in answering machine that will answer calls and take messages for you when you are unavailable. The Answering Machine records the voice message and lets you play it back with captions. Up to 63 recordable messages can be saved, each message can be up to 2 minutes long.

To turn the Answering Machine On:



1. With the handset hung up, press the **YES** button to see the Options menu.



2. Press the **DOWN** arrow button until **Answering Machine** is highlighted. Press the **YES** button to select.



3. Check that **Answering Machine On/Off** is highlighted. Press the **YES** button to select.



4. Use the **UP** or **DOWN** arrow buttons to highlight **Answering Machine On** or **Off**. Press the **YES** button to select.



5. Press the **NO** button repeatedly to Exit.



The Answering Machine will stay on or off until you change this setting.

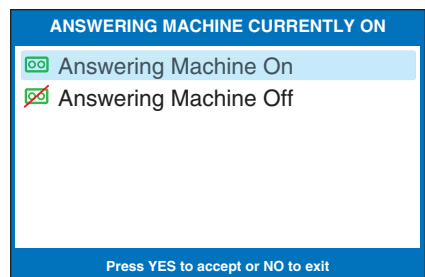
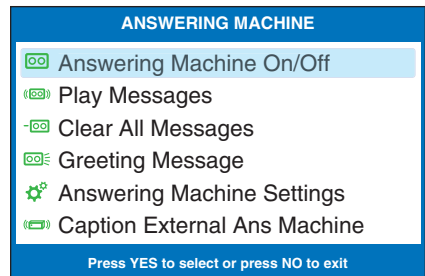
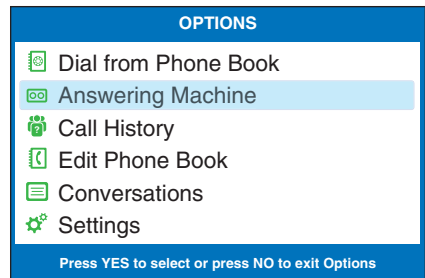

**TIP:** When the phone is not in use, the Answering Machine icon () appears in the CapTel display screen whenever the Answering Machine is turned on, letting you quickly check at a glance if the Answering Machine is turned on or off.

# Playing your Answering Machine Messages

You can listen to your Answering Machine messages over the *CapTel* handset, while at the same time reading captions of what the messages say. There are two ways to play your Answering Machine messages:

## Option 1: From *CapTel* Display Screen



1. The *CapTel* display lets you know when there are new messages waiting for you. Press the **UP** button to listen to new messages.
2. Follow the directions on the display screen to lift the *CapTel* handset and listen to your messages.

CAPTIONS



3. The CAPTIONS light will go off and captions of the recorded message will appear on the display screen.
4. When you are finished listening to each message, you can:  
Press **YES** to erase the message;  
Press **NO** to replay the current message;  
Press **UP** arrow button to review previous messages;  
Press **DOWN** arrow button to move to the next message
5. Hang up the handset when you are finished playing your messages.

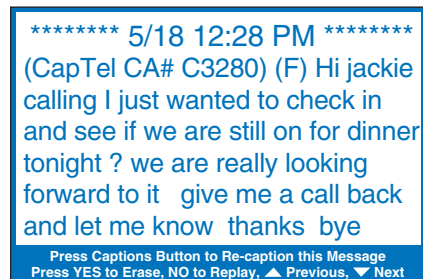
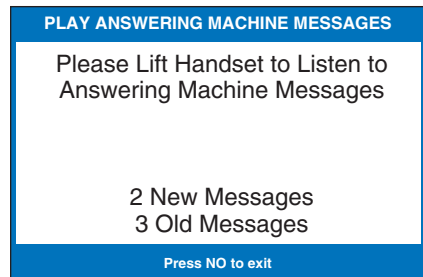
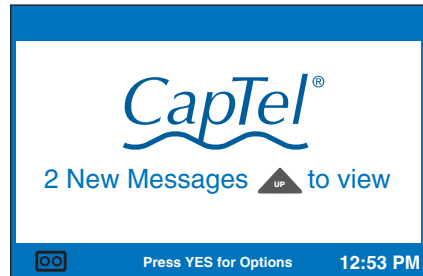

**NOTE:** *If you need to, you can have the message re-captioned. This is helpful if you notice a word error in the captions. Just press the CAPTIONS button, and the answering machine message will play over again – with new captions.*

## Option 2: From the Options Menu



1. With the handset hung up, press the **YES** button to see the Options menu.



2. Press the **DOWN** arrow button until **Answering Machine** is highlighted. Press the **YES** button to select.



3. Press the **DOWN** arrow button to highlight **Play Messages**. Press the **YES** button to select.



4. Follow the directions on the display screen to lift the *CapTel* handset and listen to your messages.

CAPTIONS



5. The **CAPTIONS** light will go off, and captions of the message will appear on the display screen while the message is playing.

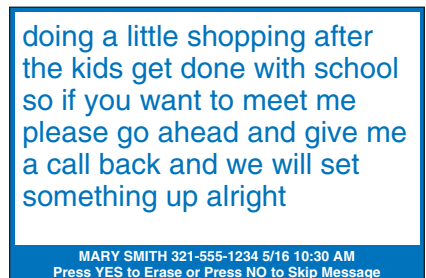
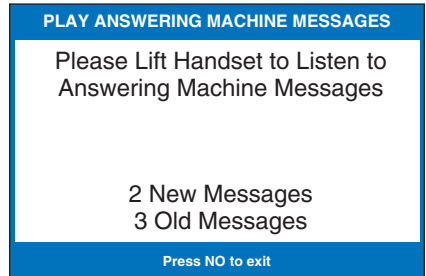
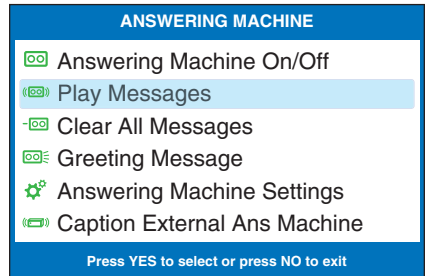
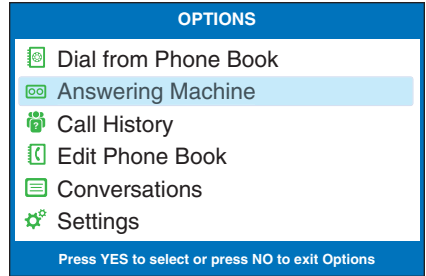

6. When you are finished listening to each message, you can:  
Press **YES** to erase the message;  
Press **NO** to replay the current message;  
Press **UP** arrow button to review previous messages;  
Press **DOWN** arrow button to move to the next message

**NOTE:** *If you need to, you can have the message re-captioned. This is helpful if you notice a word error in the captions. Just press the CAPTIONS button, and the answering machine message will play over again – with new captions.*

7. When you are finished playing your messages, hang up the CapTel handset.

**NOTE:** *The CapTel display screen stays ON whenever there is a new answering machine message that has not been reviewed, alerting you to new messages (unless the Keypad Light Timeout feature is set – then the display screen will go off after 60 seconds of non-use).*

so if you want to meet me  
please go ahead and give me  
a call back and we will set  
something up alright I hope  
you can make it looking  
forward to seeing you bye

Press Captions Button to Re-caption this Message  
Press YES to Erase, NO to Replay, ▲ Previous, ▼ Next

FINISHED PLAYING MESSAGES

Hang Up the Phone to Exit

# Clearing All Messages

In addition to erasing messages one at a time as you play them, you can also erase all your saved Answering Machine messages at one time.

To clear all your Answering Machine messages:



1. With the handset hung up, press the **YES** button to see the Options menu.



2. Press the **DOWN** arrow button until **Answering Machine** is highlighted. Press the **YES** button to select.



3. Press the **DOWN** arrow button repeatedly to highlight **Clear All Messages**. Press the **YES** button to select.



4. Press the **YES** button to erase all saved Answering Machine messages. If you don't want to erase all messages, press the **NO** button to exit.



5. *CapTel* confirms that your Answering Machine messages have been erased.

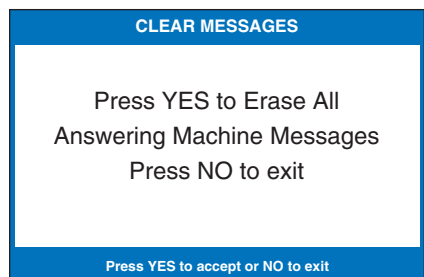
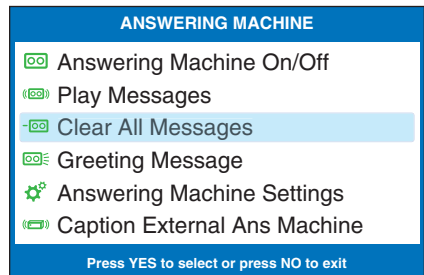
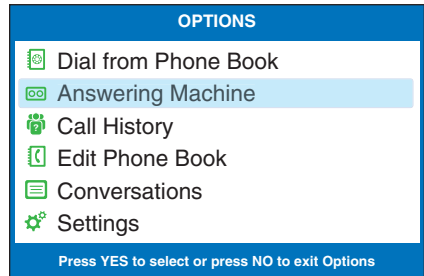

# Recording a Personal Greeting Message

Before you begin making/receiving calls, you may want to record a personal greeting message for the CapTel 840i Answering Machine. If you do not want to record a personal greeting, the Answering Machine will use a pre-recorded greeting that says, *“Hello. No one is available to take your call. Please leave a message after the tone.”*

To record a personal greeting message:

1. With the handset hung up, press the **YES** button to see the Options menu.
2. Press the **DOWN** arrow button to highlight **Answering Machine**. Press **YES** to select.
3. Press the **DOWN** arrow button to highlight **Greeting Message**. Press **YES** to select.
4. Press the **DOWN** arrow button to highlight **Record New Greeting**. Press **YES** to select.

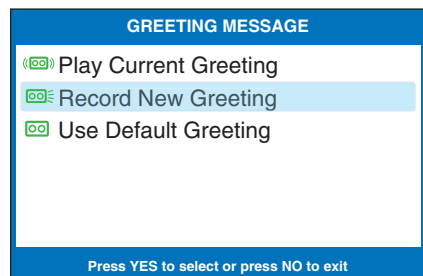
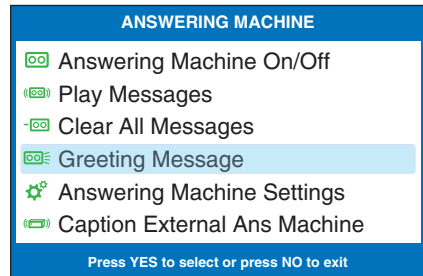
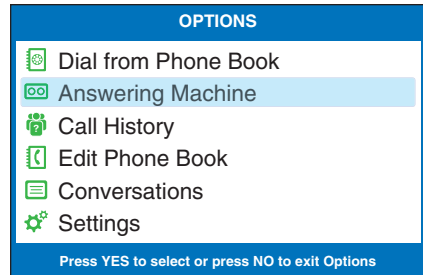

5. Lift the *CapTel* handset and watch the display screen to know when to start speaking. When you see the **REC** message, begin speaking into the handset to record your greeting message.



6. When you are finished, press the **YES** button to stop. Your new message will be played back over the handset for you to review.

If you'd like to re-record your greeting, press the **NO** key to begin recording again.

7. When you are satisfied with your new greeting, hang up the telephone handset. *CapTel* will send out your personal greeting whenever the Answering Machine picks up a call.



# Setting the Number of Rings Before Answering

You can set the approximate number of times the *CapTel* will ring before the Answering Machine answers the call. The default setting is four (4) rings, but you can set it to be any number of rings between three and eight.

**NOTE:** *The ring count may be slightly different in telephone systems that use “distinctive” ring patterns. Please experiment with this setting as needed for your specific phone system.*

To set the number of rings before answering:

1. With the handset hung up, press the **YES** button to see the Options menu.
2. Press the **DOWN** arrow button until **Answering Machine** is highlighted. Press the **YES** button to select.
3. Press the **DOWN** arrow button repeatedly until **Answering Machine Settings** is highlighted. Press the **YES** button to accept.
4. Check that **Answer Ring Count** is highlighted. Press the **YES** button to accept.

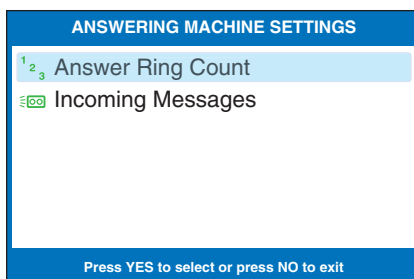
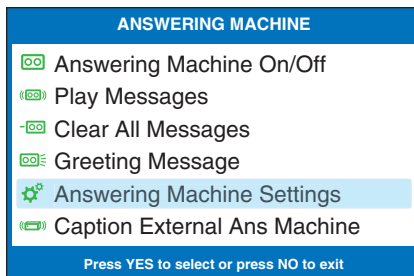
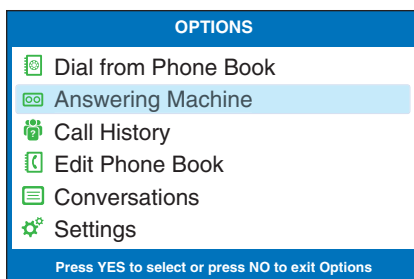





5. Use the **UP** or **DOWN** arrow buttons to select the number of rings, from 3 rings up to 8 rings. Press the **YES** button to select.

6. Press the **NO** button repeatedly to exit.

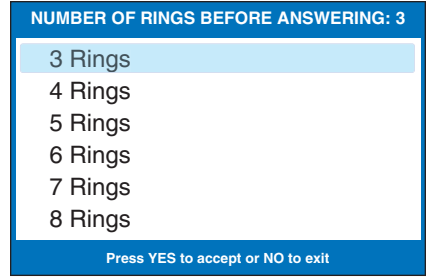







On incoming calls, your *CapTel* phone will ring this number of times before the Answering Machine picks up the call.

# Making Incoming Messages Audible/Silent

Just like with other Answering Machines, you can “screen” callers by having incoming messages played aloud on the *CapTel* phone for you to hear before you answer the call. While this is a convenient feature, there may be times when you do not want incoming messages to be played aloud, but instead taken silently for you to review at a later time. The default setting is for incoming messages to be muted (silent).

To make incoming calls audible or set them to be silent:

-  1. With the handset hung up, press the **YES** button to see the Options menu.
-   
 2. Press the **DOWN** arrow button until **Answering Machine** is highlighted. Press the **YES** button to select.
-   
 3. Press the **DOWN** arrow button repeatedly until **Answering Machine Settings** is highlighted. Press the **YES** button to accept.
-   
 4. Press the **DOWN** arrow button so that **Incoming Messages** is highlighted. Press the **YES** button to accept.

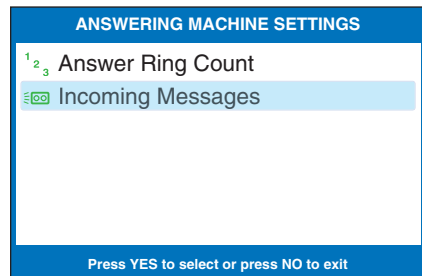
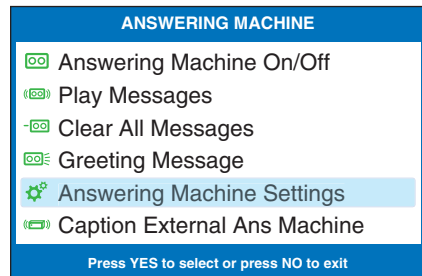
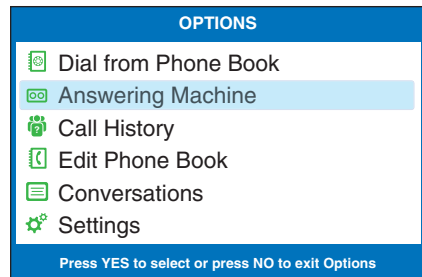



5. Press the **UP** or **DOWN** arrow button to highlight **Incoming Messages Audible** or **Muted**. Press the **YES** button to accept the setting you want.









**Incoming Messages Audible:** will play incoming messages aloud on the *CapTel* phone as the message is being taken for you to listen to/screen as they are recorded.

**Incoming Messages Muted:** will take incoming messages silently, you will not be able to hear the message as it is being taken. You will be able to listen to and review the message after it has been recorded.

# Caption External Answering Machine Messages

Your *CapTel* 840i can also show captions of messages that callers leave on your external voice answering machine. External answering machines are separate devices that you connect to your *CapTel* by a telephone line.

To get captions of your external answering machine messages:

-  1. With the handset hung up, press the **YES** button to see Options.
-   
 2. Press the **DOWN** button until **Answering Machine** is highlighted. Press the **YES** button to select.
-   
 3. Press the **DOWN** button repeatedly until **Caption External Ans. Machine** is highlighted. Press the **YES** button to accept.
-  4. The display shows that *CapTel* is ready to caption messages. Press the **YES** button to accept.
5. Lift the *CapTel* 840i handset, and place it next to your answering machine speaker. Make sure the mouth-piece of the handset is next to the speaker of your answering machine. While you do this, your *CapTel* 840i connects to the captioning service.

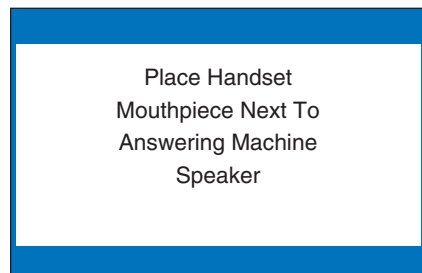
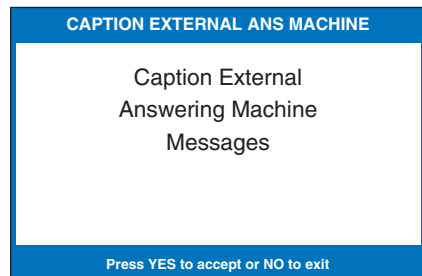
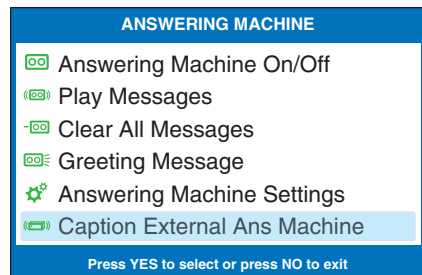
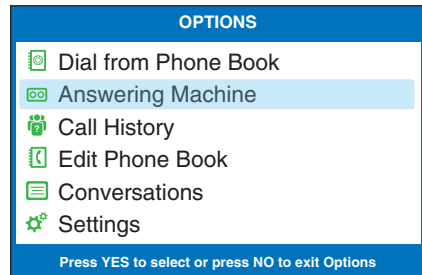

6. The display shows you when captions are ready. Press the “PLAY” button on your answering machine to play the messages aloud.

Your *CapTel* 840i will show you captions of the answering machine messages as they are played. During this time, you may operate your answering machine the same way you normally do, using the answering machine features such as play, re-play, delete, or save messages.

7. When you are done listening to your messages/reading captions, hang up the *CapTel* 840i handset.

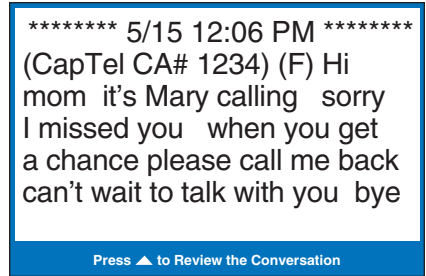

# Using the Phone Book

*This section explains how to save frequently-called phone numbers into your phone book for easy dialing.*

## TOPICS:

- **Adding a New Contact to your Phone Book**
- **Dialing a Phone Number from the Phone Book**
- **Editing an Existing Contact in the Phone Book**
- **Removing a Contact from your Phone Book**

# Adding a New Contact to your Phone Book

You can save 97 names and phone numbers in the *CapTel* 840i Phone Book. To add a new contact to the Phone Book:



1. With the handset hung up, press the **YES** button to see the Options menu.



2. Press the **DOWN** arrow button repeatedly until **Edit Phone Book** is highlighted. Press the **YES** button to select.



3. Press the **DOWN** arrow button until **Add a New Contact** is highlighted. Press the **YES** button to select.



4. Use the dialing pad to enter the letters of the name of the person you wish to add. Look for the letters listed on the number keys to know which number key to press. For some letters, press the number key several times until the correct letter appears on the display screen.

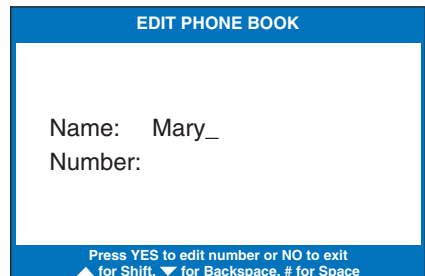
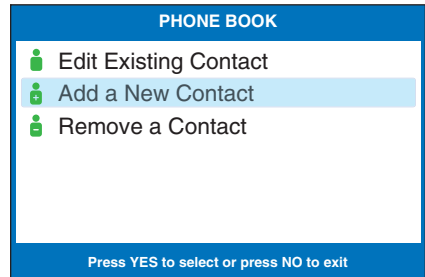
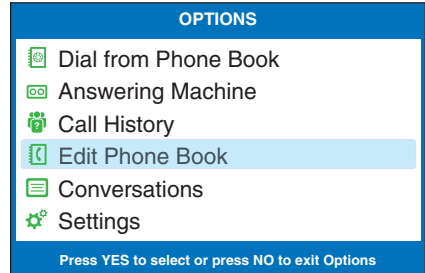

**Example:** To enter the letter “L”, press the number 5 key three times until you see “L” on the display screen.

**Example:** To enter the name “Mary”, press the 6 key for the letter “M”, the 2 key for the letter “a”, the 7 key three times for the letter “r”, then the 9 key three times for the letter “y”. You may need to wait for the cursor to change from | to \_ when entering letters that are on the same number key.

**TIP:** Press the DOWN arrow button for a backspace. Press the # button to add a space. Press the UP arrow button to shift lock for capital letters. Press UP again to return to lower case.



5. Once you have entered the contact name, press the **YES** button to advance to the Number section.



6. Enter in the phone number by using the dialing pad. Use the **DOWN** arrow button to backspace. *CapTel* automatically inserts a hyphen as you enter the phone number.

A screenshot of a phone's "EDIT PHONE BOOK" screen. The title bar is blue with white text. The main area is white and contains "Name: Mary" and "Number: \_". At the bottom, a blue bar contains white text: "Press YES to accept or NO to exit" followed by "▼ for Backspace, ▲ for 2 second delay".

**NOTE:** If a dialing prefix is required to get an outside line, enter in the dialing prefix first, then the phone number. Use the **UP** button to add a 2-second delay.



7. When you are done entering the phone number, press the **YES** button to save your new contact information.

A screenshot of a phone's "EDIT PHONE BOOK" screen. The title bar is blue with white text. The main area is white and contains "Name: Mary" and "Number: 555-1234\_". At the bottom, a blue bar contains white text: "Press YES to accept or NO to exit" followed by "▼ for Backspace, ▲ for 2 second delay".

Press the **YES** button to enter more contact names/phone numbers, or press the **NO** button repeatedly to exit the menu system.



**NOTE:** Phone book entries are stored alphabetically by the first letter of the name.



# Dialing a Phone Number from the Phone Book

To quickly dial any phone number listed in your Phone Book:



1. With the handset hung up, press the **YES** button to see the Options menu.



2. Make sure **Dial from Phone Book** is highlighted. Press the **YES** button to select.



3. The display screen shows you the first contact name and number listed in your Phone Book. Use the **UP** and **DOWN** arrows to move through the contacts in your Phone Book.

4. When you see the contact listing you want to dial, simply lift the handset. The *CapTel* phone will dial the number for you automatically.

CAPTIONS



5. Make sure the **CAPTIONS** button is on (red light on). You can turn captions on/off at any time in your conversation.

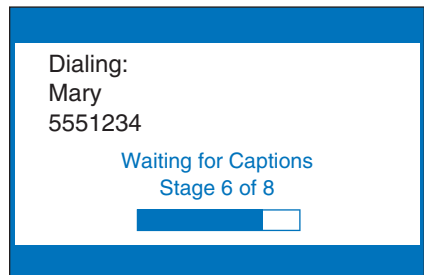
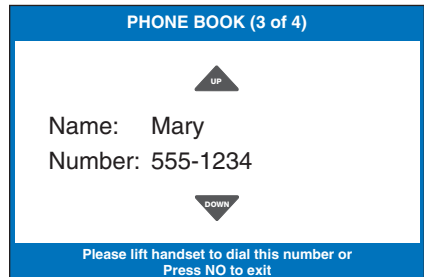
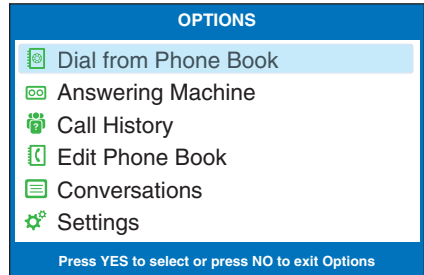

# Editing an Existing Contact in the Phone Book

To make changes to an existing contact in the Phone Book:

1. With the handset hung up, press the **YES** button to see the Options menu.
2. Press the **DOWN** arrow button repeatedly until **Edit Phone Book** is highlighted. Press the **YES** button to accept.
3. Check that **Edit Existing Contact** is highlighted.
4. Press the **YES** button to select.
5. The display screen will show you the first listing in your Phone Book. Use the **UP** and **DOWN** arrow buttons to move through the various contacts in your Phone Book. When you find the contact you wish to change, press the **YES** button to select it.

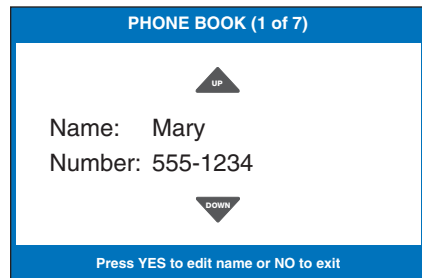
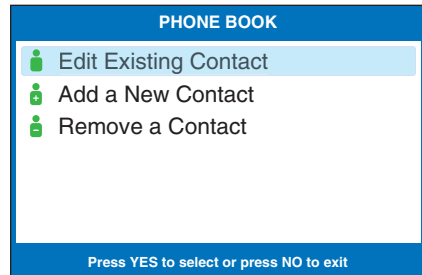
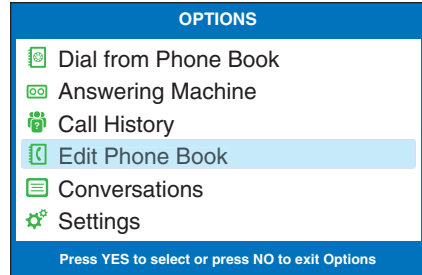



6. To edit the name, use the **DOWN** arrow button as a backspace to erase letters. You can enter new/different letters using the dialing pad. Look for the letters listed on the number keys to know which number key to press. For some letters, press the same number key several times until the correct letter appears on the display screen.

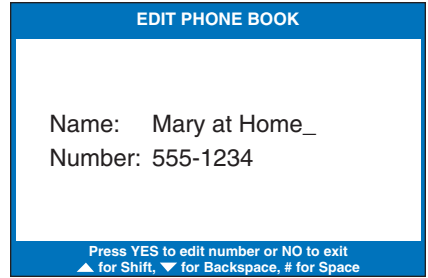

7. When you are done editing the name, press the **YES** button to move to the Number.

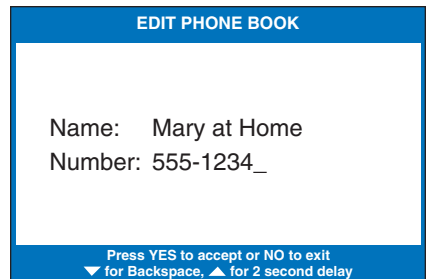

To edit the phone number, use the **DOWN** arrow button as a backspace to erase numbers. You can enter new/different numbers using the dialing pad. Use the **UP** arrow button to insert a 2-second delay.

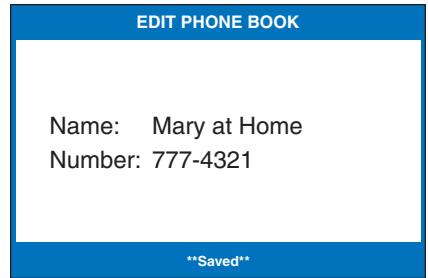

**NOTE:** *If a dialing prefix is required to get an outside line, enter in the dialing prefix first, then the phone number.*



8. When you are done editing the phone number, press the **YES** button to save your changes.









9. Press the **YES** button to edit more contacts in your Phone Book, or press the **NO** button repeatedly to exit the menu system.



# Removing a Contact from your Phone Book

To remove a contact from your Phone Book:

-  1. With the handset hung up, press the **YES** button to see the Options menu.
-  2. Press the **DOWN** arrow button repeatedly until **Edit Phone Book** is highlighted. Press the **YES** button to select.
-  3. Press the **DOWN** arrow button repeatedly until **Remove a Contact** is highlighted. Press the **YES** button to select.
-   
 4. The display screen will show you the first listing in your Phone Book. Use the **UP** and **DOWN** arrow buttons to move through the various contacts in your Phone Book until you see the contact listing you wish to delete.
-  5. Press the **YES** button to remove the contact listing. The name and phone number of the contact person will be deleted from the Phone Book.
-  6. Press the **NO** button repeatedly to exit out of the Options menu.

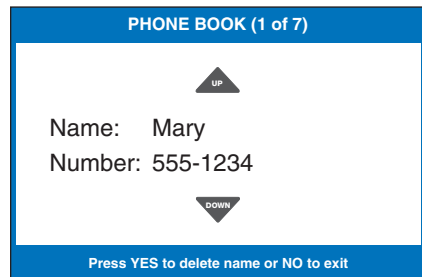
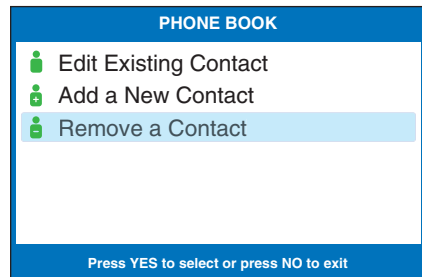
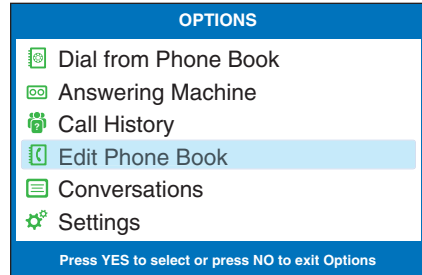

# Using Speed Dial Buttons

*This section tells you how to set up and use the three Speed Dial buttons on your CapTel phone.*

## TOPICS:

- **About the Speed Dial Buttons**
- **Saving Phone Numbers in the Speed Dial Buttons**
- **Editing Phone Numbers in the Speed Dial Buttons**
- **Dialing with the Speed Dial Buttons**

## About the Speed Dial Buttons

---

You can set up three speed dial buttons on your *CapTel* phone to easily dial your most frequently-called phone numbers. You may want to use these buttons for emergency speed dial buttons to call the fire department or police, or to quickly reach the phone numbers you call most often.

# Saving Phone Numbers in the Speed Dial Buttons

SPEED  
DIAL

1

1. With the handset hung up, press the **SPEED DIAL** button you want to program.

YES

2. Press the **YES** button to edit.

3. Use the dialing pad to enter the letters of the name of the person you wish to add. Use the letters on the number keys to know which key to press.

**Example:** To enter the name “Mary”, press the 6 key for the letter “M”, the 2 key for the letter “a”, the 7 key three times for the letter “r”, then the 9 key three times for the letter “y”. You may need to wait for the cursor to change from | to \_ when entering letters that are on the same number key.

YES

4. Press the **YES** button to advance the selection to the Number section.

5. Enter in the phone number by using the dialing pad. (*NOTE: If a dialing prefix is required to get an outside line, enter in the dialing prefix then the numbers.*) Use the **DOWN** arrow button to backspace. Use the **UP** arrow button to insert a 2-second delay. CapTel will automatically insert a hyphen as you enter the phone number.

YES

6. Press the **YES** button to save it.

SPEED DIAL 3

Name:  
Number:

Press YES to edit or NO to exit

EDIT SPEED DIAL

Name: \_  
Number:

Press YES to edit number or NO to exit  
▲ for Shift, ▼ for Backspace, # for Space

EDIT SPEED DIAL

Name: Mary  
Number: \_

Press YES to accept or NO to exit  
▼ for Backspace, ▲ for 2 second delay

# Editing Phone Numbers in the Speed Dial Buttons

SPEED  
DIAL



1. Press the **SPEED DIAL** button you wish to edit.



2. Press the **YES** button to edit the name.



3. Use the **DOWN** arrow button to backspace/erase letters in the current name. Use the number pad keys to enter a new letter or name. Press the **YES** button when you are done editing the name.



4. The cursor moves to the Number entry. Use the **DOWN** arrow button to backspace/erase numbers in the current listing. Use the number pad key to change/enter a new phone number. Use the **UP** arrow button to insert a 2-second delay.



5. When you are finished making changes, press the **YES** button to accept.

**SPEED DIAL 1**

Name: Mary  
Number: 555-1234

Please lift handset to dial this number  
Press YES to edit or NO to exit

**EDIT SPEED DIAL**

Name: Mary Cell\_  
Number: 555-1234

Press YES to edit number or NO to exit  
▲ for Shift, ▼ for Backspace, # for Space

**EDIT SPEED DIAL**

Name: Mary Cell  
Number: 789-3456\_

Press YES to accept or NO to exit  
▼ for Backspace, ▲ for 2 second delay

# Dialing with the Speed Dial Buttons

CAPTIONS



1. Make sure the **CAPTIONS** button is on (red light on).

SPEED  
DIAL



2. Press the **SPEED DIAL** key with the number that you want to call.

3. Lift the handset. Your *CapTel* phone will dial the phone number for you automatically.

4. Listen or watch the signal meter to know when someone answers. Watch the display screen for captions. Begin your conversation as you normally would.

When you are done with your call, hang up the handset.

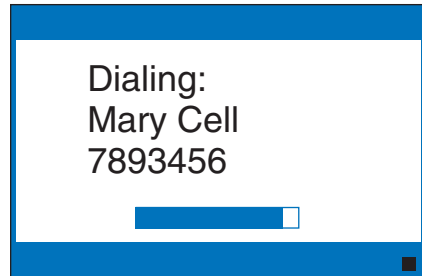
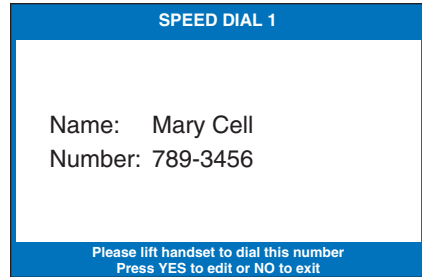



# Settings

*This section explains how to adjust settings on your phone to fit your preferences.*

## TOPICS:

- **Setting the Captions Button to On/Off**
- **Turning Spanish Captions On/Off**
- **Adjusting the Volume of the Ringer**
- **Setting the Pitch of the Ringer**
- **Turning Keypad Lights On/Off**
- **Saving the Captions Volume**
- **Setting your *CapTel* Phone for Tone/Pulse Dialing**
- **Changing the Network Settings**
- **Removing Saved Networks**
- **Setting the Time and Date**
- **Using Call Waiting**
- **Dialing 911 with Your *CapTel* 840i**
- **Updating your *CapTel* Phone**

# Setting the Captions Button to On/Off

---

You can change the default setting of your *CapTel* 840i to always have the CAPTIONS button set to ON or to always have the CAPTIONS button set to OFF. Your *CapTel* 840i comes with the Captions button default set to ON.

**NOTE:** *No matter how you set the Captions button default, you can always turn the captions ON or OFF by pressing the CAPTIONS button at any point in the conversation.*

CAPTIONS

## Captions Button Default On



When the Captions button default is set to ON, every call (incoming or outgoing) is automatically connected to the Captioning Service. The light around the **CAPTIONS** button remains lit. You will receive captions on every call. You can still turn the captions off by pressing the **CAPTIONS** button at any time during the call.

CAPTIONS

## Captions Button Default Off



When the Captions button default is set to OFF, calls are not automatically connected to the Captioning Service. The light around the **CAPTIONS** button stays off. Calls are treated exactly like any regular telephone call, with you and the other party talking over the telephone line and no captions involved. Even with the Captions button default set to off, you can turn captions on by pressing the **CAPTIONS** button at any time during the call.

**NOTE:** *When the **CAPTIONS** button is off (red light is off) the maximum amplification level is not available.*

To change the Captions button setting:



1. With the handset hung up, press the **YES** button to see the Options menu.



2. Press the **DOWN** arrow button repeatedly to highlight **Settings**.



3. Press the **YES** button to select.



4. Check that **Caption Settings** is highlighted. Press the **YES** button to select.



5. Check that **Captions Button** is highlighted. Press the **YES** button to select.



6. Press the **UP** or **DOWN** arrow button to select **Captions On** or **Captions Off**.

**Captions On:** Captions will automatically be on every call.

**Captions Off:** You will need to press the CAPTIONS button to turn the Captions feature on and off for each call.



7. Press the **YES** button to accept.



8. Press the **NO** button repeatedly to exit out of the Options menu.

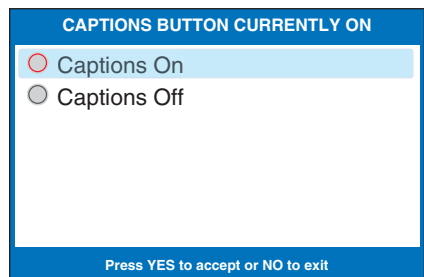
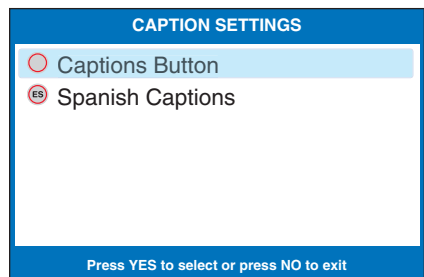
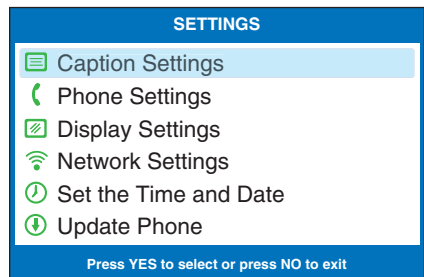
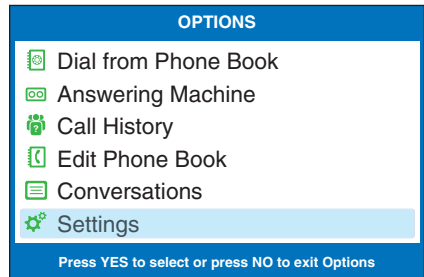

# Turning Spanish Captions On/Off

Your *CapTel* 840i phone can display captions in Spanish for Spanish-to-Spanish conversations. Setting the captions to Spanish language also changes the Options menu to display in Spanish.

**NOTE:** *Spanish captioning is available for Spanish-to-Spanish conversations only. The CapTel 840i phone does not translate from English conversations to Spanish captions.*

To turn Spanish captions on:



1. With the handset hung up, press the **YES** button to see the Options menu.



2. Press the **DOWN** arrow button repeatedly until **Settings** is highlighted. Press the **YES** button to select.



3. Check that **Caption Settings** is highlighted. Press the **YES** button to select.



4. Check that **Spanish Captions** is highlighted. Press the **YES** button to select.

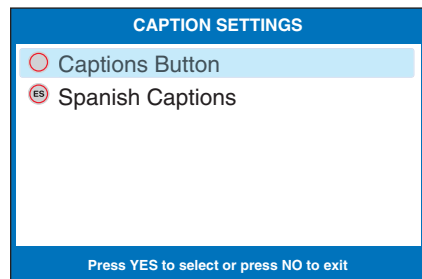
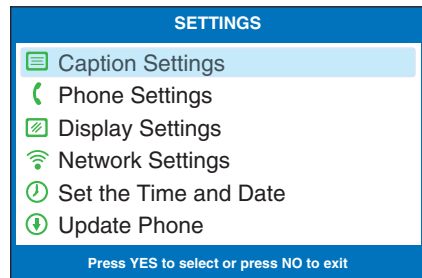
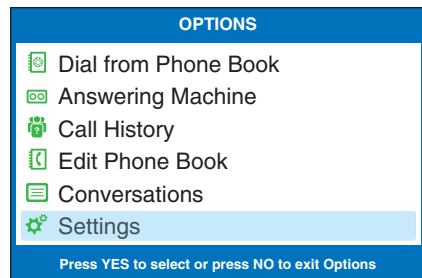



5. Press the **UP** or **DOWN** arrow button to select **Spanish Captions On** or **Spanish Captions Off**.



6. Press the **YES** button to accept.



7. Press the **NO** button to exit out of the Options menu.

You are now ready to make and receive calls with captions in Spanish. To make a call with Spanish language captions, lift the handset and dial the number you want to call.

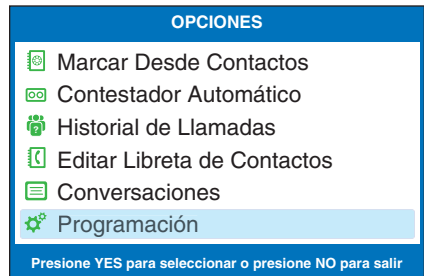
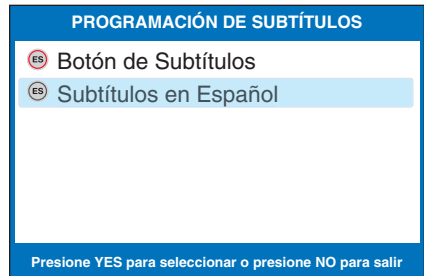
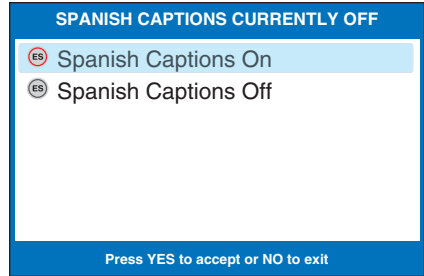

**NOTE:** *Spanish captions must be turned on in order for you to receive captions in Spanish. If Spanish captions are turned off and a Spanish-speaking person calls you, their captions will not appear in Spanish. You will need to ask them to call you back in a few minutes, after you've had a chance to turn Spanish captions on.*

**Spanish-to-Spanish captioning available every day from  
7:00 a.m. – 11:00 p.m. CST  
For Spanish-language Customer Support: 1-866-670-9134**

# Adjusting the Volume of the Ringer

You can set the volume of the *CapTel* 840i ringer to the volume that you hear best: Choose from minimum volume (105 dB), medium volume (111 dB), maximum volume (117 dB), or Mute (turns Ringer off).

To set the Ringer volume:



1. With the handset hung up, press the **YES** button to see the Options menu.



2. Press the **DOWN** arrow button until **Settings** is highlighted. Press the **YES** button to select.



3. Press the **DOWN** arrow button to highlight **Phone Settings**. Press the **YES** button to select.



4. Check that **Ringer Volume** is highlighted.



5. Press the **YES** button to select.



6. Press the **UP** or **DOWN** arrow button to select your desired Ringer Volume level. To turn the Ringer off entirely, select Mute.



7. When the volume setting you want is highlighted, press the **YES** button to accept.



8. Press the **NO** button repeatedly to exit out of the Options menu.

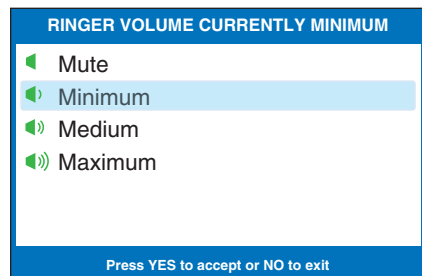
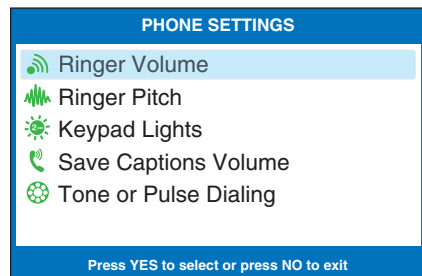
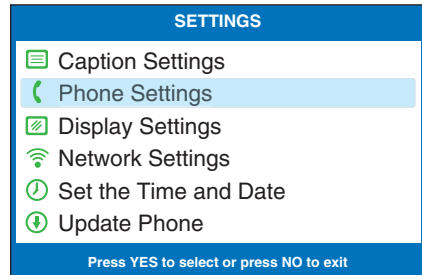
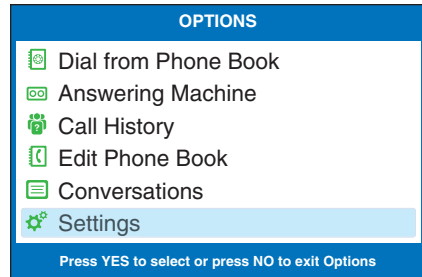

# Setting the Pitch of the Ringer

You can select the Ringer Pitch that helps you hear best, selecting from Low, Medium, or High frequency pitch.

To set the Ringer pitch:



1. With the handset hung up, press the **YES** button to see the Options menu.



2. Press the **DOWN** arrow button until **Settings** is highlighted. Press the **YES** button to select.



3. Press the **DOWN** arrow button to highlight **Phone Settings**. Press the **YES** button to select.



4. Press the **DOWN** arrow button until **Ringer Pitch** is highlighted. Press the **YES** button to select.



5. Press the **UP** or **DOWN** arrow button to select your desired Ringer Pitch level. The ringer will ring briefly as you switch levels.



6. When the **Ringer Pitch** level that you want is highlighted, press the **YES** button to accept.



7. Press the **NO** button repeatedly to exit out of the Options menu.

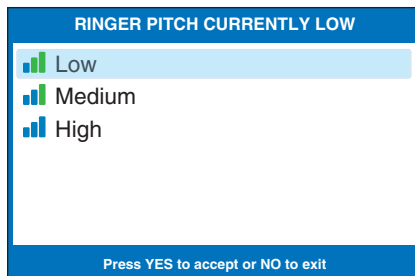
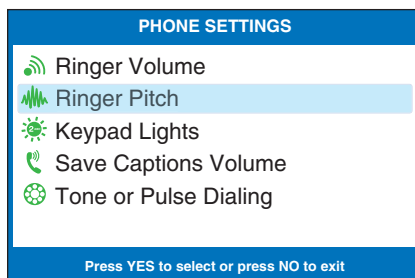
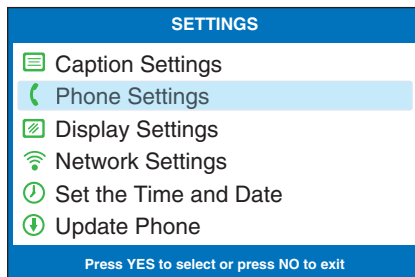
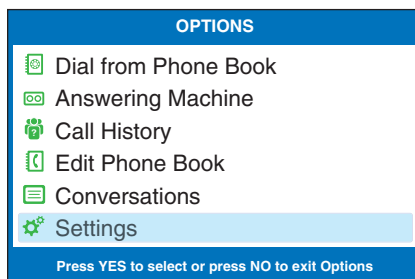

# Turning Keypad Lights On/Off

The *CapTel* 840i dialing keypad is lit to make it easier to see the number keys. The lights on the number keypad can be turned off in the *CapTel* Options menu. When Keypad Lights Timeout is selected, the lights on the number keypad go off automatically after approximately 60 seconds of non-use.

To turn the lights on the number keypad off:



1. With the handset hung up, press the **YES** button to see the Options menu.



2. Press the **DOWN** arrow button until **Settings** is highlighted. Press the **YES** button to select.



3. Press the **DOWN** arrow button to highlight **Phone Settings**. Press the **YES** button to select.



4. Press the **DOWN** arrow button repeatedly until **Keypad Lights** is highlighted. Press the **YES** button to select.

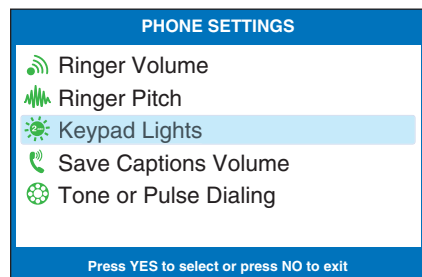
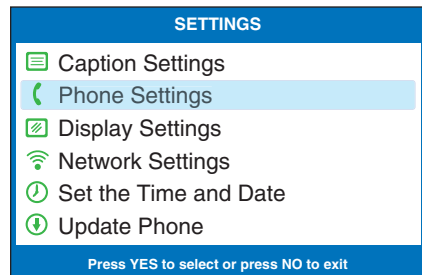
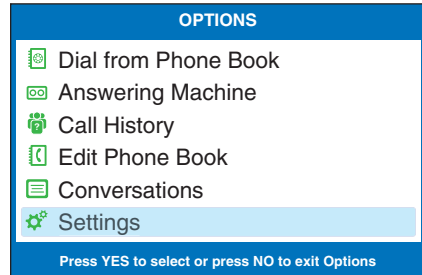





4. Press the **UP** or **DOWN** arrow button to turn Keypad Lights Always On or Keypad Lights Timeout.

**NOTE:** *When Keypad Lights Timeout is selected, the dialing keypad lights will go off whenever the display is blank (after approximately 60 seconds of non-use). The lights will remain on when the phone is in use.*



5. Press the **YES** button to select your option, or press the **NO** button to exit.



6. Press the **NO** button repeatedly to exit out of the Options menu.

**NOTE:** *The CapTel display screen typically stays on whenever you have new answering machine messages that have not been reviewed. If you set Keypad Light Timeout, however, the CapTel display screen will also turn off after approximately 60 seconds of non-use.*

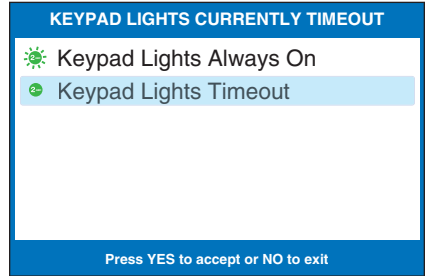

# Saving the Captions Volume

The volume level automatically returns to a mid-range setting each time you hang up the *CapTel* phone. You can set the *CapTel* to remember and use your preferred volume level on every captioned call. The saved volume only applies when the CAPTIONS button is on. When the CAPTIONS button is off, your *CapTel* phone will return to a mid-range volume every time you hang up.

To save your volume setting for captioned calls:

1. With the handset hung up, press the **YES** button to see the Options menu.
2. Press the **DOWN** arrow button repeatedly until **Settings** is highlighted. Press the **YES** button to select.
3. Press the **DOWN** arrow button until **Phone Settings** is highlighted. Press the **YES** button to select.
4. Press the **DOWN** arrow button repeatedly until **Save Captions Volume** is highlighted. Press the **YES** button to select.

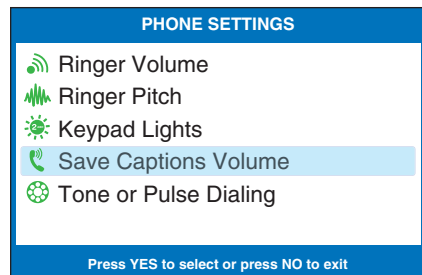
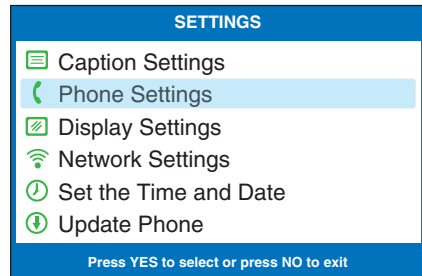
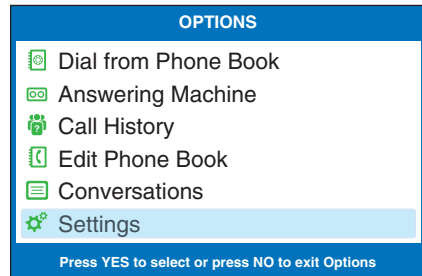



5. Use the **UP** or **DOWN** arrow buttons to highlight **Save Captions Volume** or **Do Not Save Captions Volume**. Press **YES** to select.



6. Press the **NO** button repeatedly to exit.

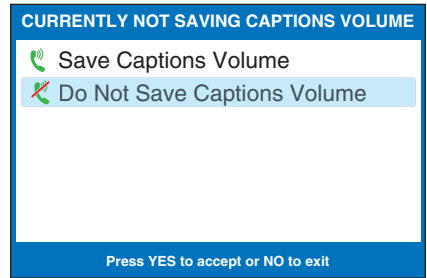

Now, during your next call with captions, experiment with the volume button to find a level that works best for you. Whatever volume setting you choose will be saved in *CapTel* memory, and will be used for every call that has the CAPTIONS button lit. During non-captioned calls (CAPTIONS button off), the volume will automatically start at a mid-range setting, and will have to be adjusted manually.

**NOTE:** *This setting will remain in effect until you go through the process again to select **Do Not Save Captions Volume**.*

# Setting your CapTel Phone for Tone/Pulse Dialing

The dialing mode of your CapTel 840i phone is set to Tone dialing. To set the dialing mode to Pulse dialing:

1. With the handset hung up, press the **YES** button to see the Options menu.
2. Press the **DOWN** arrow button repeatedly until **Settings** is highlighted. Press the **YES** button to select.
3. Press the **DOWN** arrow button to highlight **Phone Settings**. Press the **YES** button to select.
4. Press the **DOWN** arrow button repeatedly until **Tone or Pulse Dialing** is highlighted.
5. Press the **YES** button to select.
6. Press the **UP** or **DOWN** arrow button to select **Tone Dialing** or **Pulse Dialing**.
7. When the dialing mode you want is highlighted, press the **YES** button to accept.
8. Press the **NO** button to exit out of the Options menu.

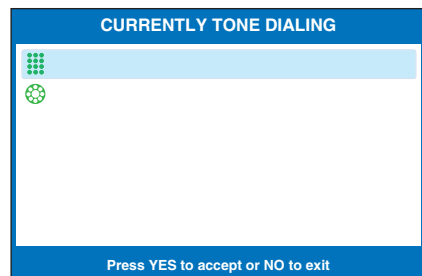
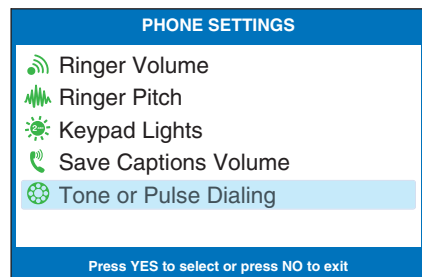
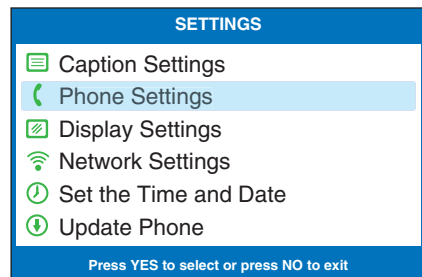
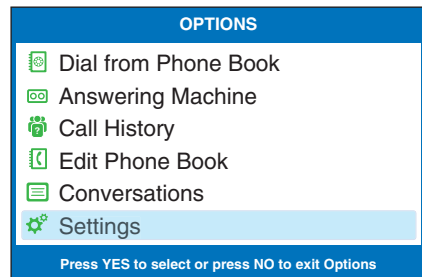

# Changing the Network Settings

If you are connected to the Internet using a WiFi network and if you want to move your *CapTel* 840i to a different location, you may need to change the network settings.



1. With the handset hung up, press the **YES** key to see the Options menu.



2. Press the **DOWN** arrow button repeatedly until **Settings** is highlighted. Press the **YES** button to select.



3. Press the **DOWN** arrow button repeatedly until **Network Settings** is highlighted. Press the **YES** button to select.



4. To view your current Network Settings, check that **View Current Network** is highlighted. Press **YES** to select.

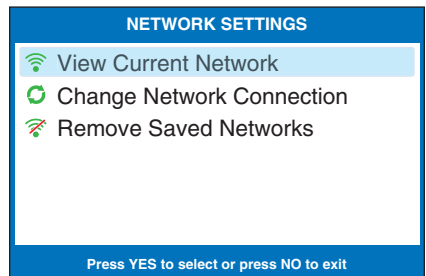
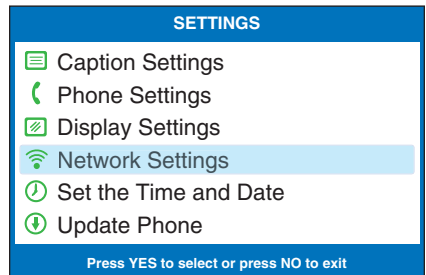
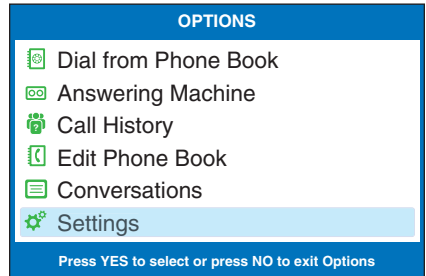



CapTel shows you your current network configuration. Press **NO** to exit.

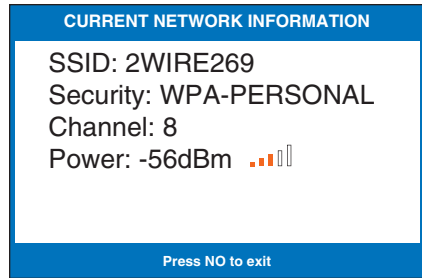

5. Press the **DOWN** arrow button to highlight **Change Network Configuration**. Press the **YES** button to select.

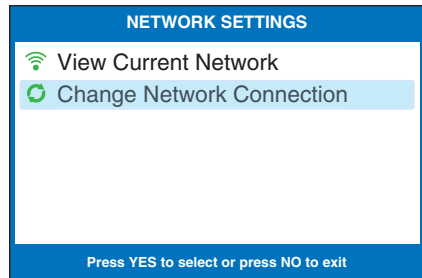

6. CapTel asks **Are You Sure You Want To Leave This Network?** Press the **YES** button to leave current network. Or, press **NO** to exit.

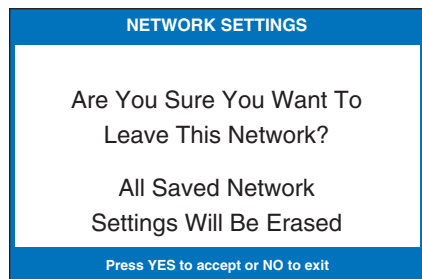

**NOTE:** *If you leave the current network setting, all saved information about your network will be erased. The CapTel will go through the Network Setup process again to re-establish a connection over the Internet. See the CapTel 840i Setup Guide for details about re-setting up a network configuration.*



# Removing Saved Networks

You can remove previously-saved WiFi networks from *CapTel* memory.

To remove saved networks:



1. With the handset hung up, press the **YES** button to see the Options menu.



2. Press the **DOWN** arrow button repeatedly until **Settings** is highlighted. Press the **YES** button to select.



3. Press the **DOWN** arrow button repeatedly until **Network Settings** is highlighted. Press the **YES** button to select.



4. Press the **DOWN** arrow button until **Remove Saved Networks** is highlighted. Press **YES** to select.



5. Use the **UP** or **DOWN** arrow buttons to highlight the network you want to remove. Press the **YES** button to select.







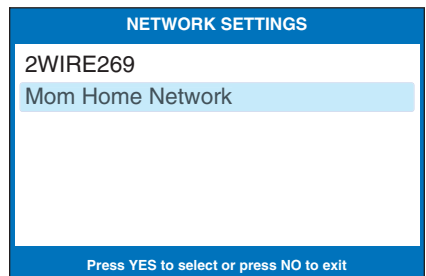
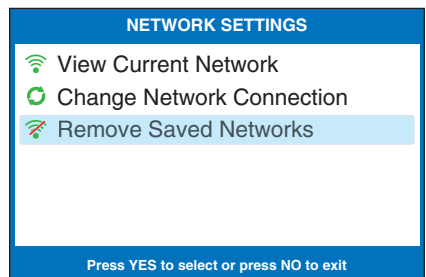
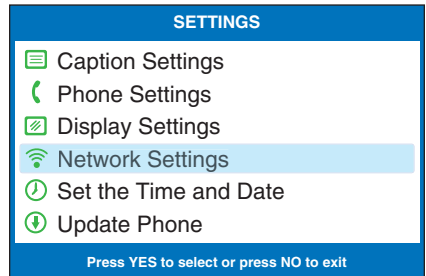
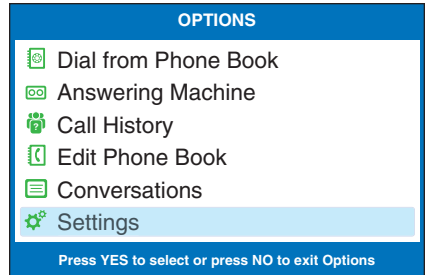

6. *CapTel* removes the network from memory.

**NOTE:** You cannot remove the network connection that is currently being used by *CapTel*.



# Setting the Time and Date

To set the time and date:

-  1. With the handset hung up, press the **YES** button to see the Options menu.
-   
 2. Press the **DOWN** arrow button repeatedly until **Settings** is highlighted. Press the **YES** button to select.
-   
 3. Press the **DOWN** arrow button repeatedly until **Set the Time and Date** is highlighted. Press the **YES** button to select.
-   
 4. *CapTel* shows you the current time and date setting. Use the **UP/DOWN** arrow buttons to move the blue highlight over the number that you want to change.
5. On the dialing pad, press the key that lists the number you want to use.

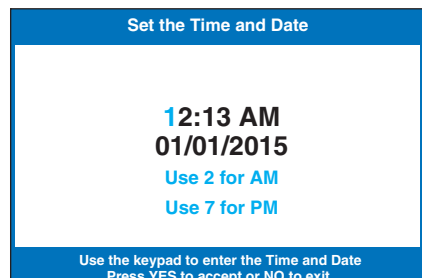
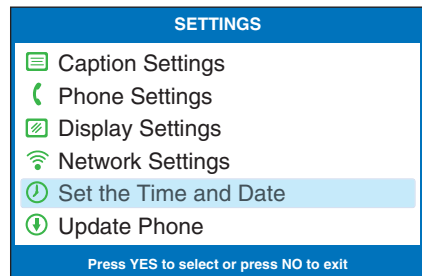
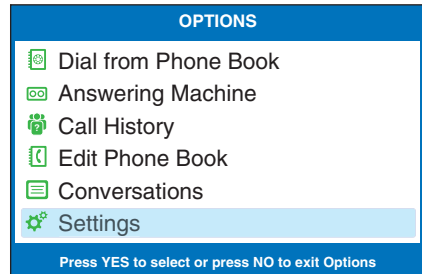

**Example:** To set the time for 11:30, press the “1” key twice, then press the “3” key followed by the “0” key.

**NOTE:** When setting the date, only the last two numbers in the year can be changed.

-  6. When you have set the time and date, press the **YES** button to save.

**TIP:** To change the time from AM to PM, press the 2 key for “AM” and the 7 key for “PM”.



# Using Call Waiting

---

You can use enhanced telephone features such as Call Waiting that you may have as part of your telephone service. With the *CapTel* 840i, you will see captions during your first conversation and during the second Call Waiting conversation as well.

To use Call Waiting:

1. During a conversation, listen for the beep or see (TONES) in the captions. It may indicate an incoming call with Call Waiting.
2. Inform the party you are speaking with on the initial call that you have another call on Call Waiting and ask if they wouldn't mind holding.

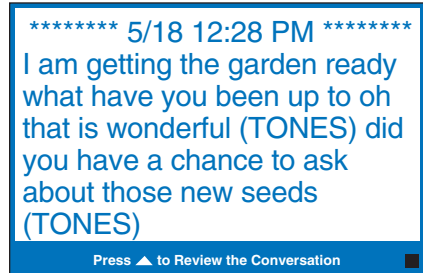

FLASH



3. Press the **FLASH** button to switch to the second call (you will receive captions of this call as well).

FLASH



4. Press the **FLASH** button to return to the first call if appropriate.

# Dialing 911 with Your *CapTel* 840i

---

With *CapTel* 840i, calls to 911 are handled exactly the same as if you called from any other phone connected to your telephone service, plus you get captions of the call directly from the *CapTel* Captioning Service. General instructions for dialing 911 are listed below. For detailed instructions about your phone service and 911, please check with your telephone service provider.

To Dial 911:

1. Pick up handset and dial 911. Your call will be directly connected to the local emergency center for your area.
-  2. Make sure the Caption button is on. If not, press the Caption button to turn the captions on. You will receive captions of everything the 911 call-taker says.
3. When 911 answers, state your emergency and confirm your location.

If you turn captions on in the middle of a call to 911, there will be a brief delay before the captions begin while the *CapTel* phone connects to the Captioning Service. During that time the 911 call-taker will be able to hear everything you say. If necessary, tell the 911 call-taker you are reading captions.

# Updating Your *CapTel* Phone

Occasionally, changes are made to the *CapTel* 840i software. Your phone can check whether new software is available and then perform an update as needed over the Internet connection. This process ensures you will always have the latest technology for as long as you own your *CapTel* 840i.

To update your *CapTel* 840i software:



1. With the handset hung up, press the **YES** button to see the Options menu.



2. Press the **DOWN** arrow button repeatedly until **Settings** is highlighted.



Press the **YES** button to select.



3. Press the **DOWN** arrow button repeatedly until **Update Phone** is highlighted.



Press the **YES** button to select.



4. Press the **YES** button to begin updating your phone, or press the **NO** button to exit.



5. The *CapTel* phone checks to make sure that your software is up to date. If a new software version is available, your *CapTel* phone updates to the most current version, then resets (reboots) itself so you are ready to make calls.

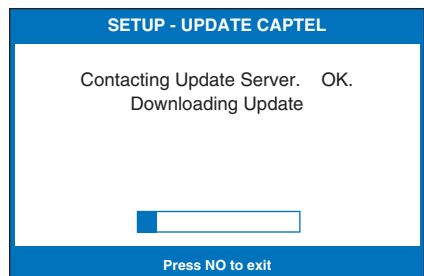
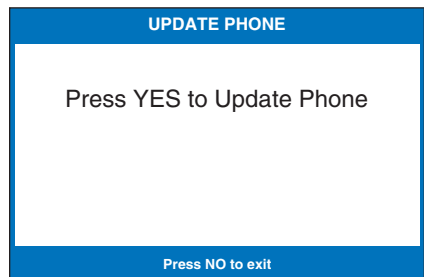
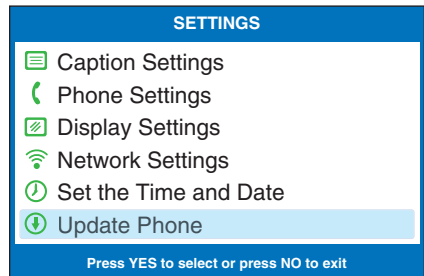
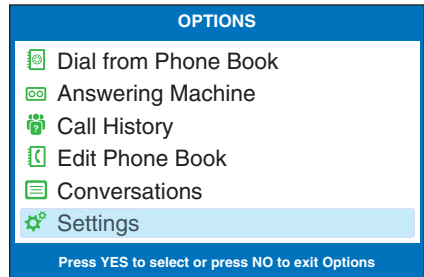

# Problem Solving

## **My *CapTel* 840i does not ring**

Check that the RINGER is not set to Mute in the Options menu. See page 78.

## **I want to make captioned calls at work, but I don't hear a dial tone when I pick up the handset.**

If you need to dial a "9" or another number to get an outside line, then you must dial the "9" before placing your call. When programming a Speed Dial button, be sure to include the dialing prefix before the phone number.

## **What does "No Network Connection" prompt on my screen mean?**

It means that the *CapTel* 840i is not able to send and receive data over the Internet. Check your connections again to confirm that you are connected to Internet service, and that your Internet service is working properly. If the problem persists, please contact *CapTel* Customer Service for help.

## **Can I use the Internet on my computer at the same time that I am on the *CapTel* 840i phone with captions?**

Yes. At times, you may experience slightly slower captions. But there should be no major difficulty using both the Internet with your computer and using your *CapTel* phone at the same time.

## **Leaving messages on answering machines**

You may begin leaving your message as soon as you see (BEEP) on the display screen or hear the recorded greeting end.

If you receive no further information, you may assume your message was recorded. If the answering machine is capable of confirming that a message was left, you will see the confirmation message on the *CapTel* display.

## Using automated (touchtone) systems

With *CapTel*, you can easily navigate through automated phone menu systems (example: press “1” for sales, press “2” for shipping, etc.). You can press number buttons at any time during a call to make selections. You do not need to wait for captions prior to pressing your selection. The captioning service continuously transcribes anything that is said over the phone, regardless of what you are saying or which buttons you press.

**NOTE:** *Some automated systems have very short response times which may disconnect you. If this happens, simply hang up and try the call again.*

## Difficulty hearing over the *CapTel* 840i handset

- Try adjusting the volume setting by pressing the VOLUME bar. To increase the volume, press and hold the right side of the bar. Watch the status lights above the VOLUME bar to know what the setting is. See page 28.
- Try adjusting the TONE setting to enhance different frequency sounds. Press the TONE key to emphasize HIGH, MEDIUM, or LOW frequency sounds. See page 29 for details.

## Display screen seems to be “stuck” at Waiting for Captions status bar. Nothing seems to be happening.

- Press the CAPTIONS button off and then on again.
- Hang up your *CapTel* 840i phone and try to place the call again.
- If you are still experiencing the problem, unplug your *CapTel* 840i from the power adapter, wait 10 seconds, then plug the power back in again. This “resets” the *CapTel* 840i, in the same way you might “reset” your computer. Try making the call again. Warning: resetting the phone will erase any conversations saved in memory.
- Try unplugging the *CapTel* AC adapter, then turning off the Router and the Internet modem. Wait a few seconds, then turn on the modem (make sure it’s fully reset, with lights going steady). Next, turn on the Router, making sure it is fully reset. Then plug in the *CapTel* phone AC adapter, all in that order. Wait for the logo screen to appear.
- If the problem still persists, please contact *CapTel* Customer Service for help.

## I sometimes see a word in [brackets] in the middle of the captions.

At times, the captioning service may correct word errors that occur in the captions. The corrected word appears in [brackets] to let you know a correction has been made. There may be a slight delay before the word error is corrected. If you are unclear about what was said, ask your caller to clarify.

### Using a Signaler with *CapTel*

To use an optional signaler light (sold separately) with *CapTel*, plug the device into an unused telephone extension jack. If you only have the one jack that is being used by your *CapTel*, you can use a “Y-jack (also called a “duplex jack”). Plug both the *CapTel* and the other device into the Y-jack and then plug the Y-jack in at the wall. You can purchase Y-jacks at any store that sells telephones.

### Sharing a Telephone Line Jack

Devices such as signalers or life line devices often have to be hooked up to the same telephone line as your *CapTel* phone. If a separate, unused telephone extension is not available/close by, you can use a “Y-jack” (also called a “duplex jack”) to connect the *CapTel* to the phone line. Plug both the *CapTel* and the other device into the Y-jack and plug the Y-jack in at the wall (see illustration). If you need to connect more than two devices at the same phone jack, please contact *CapTel* Customer Service for assistance. You can purchase a Y-Jack at any store that sells telephones.

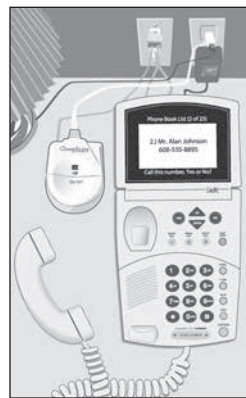

# CARE & MAINTENANCE

## Cleaning

Never use liquid or aerosol cleaners. Unplug the *CapTel* and wipe with a damp cloth. If necessary, use a small amount of mild soap such as dishwashing soap on the cloth.

# SAFETY INSTRUCTIONS

When using your *CapTel*, basic safety precautions should always be followed to reduce the risk of fire, electric shock, and injury to persons.

1. Read and understand all instructions.
2. Follow all warnings and instructions on the *CapTel*.
3. Unplug the *CapTel* from the wall outlet before cleaning. Do not use liquid or aerosol cleaners. Use a damp cloth for cleaning.
4. Do not use the *CapTel* near water, for example, near a bath tub, wash bowl, kitchen sink, laundry tub, in a wet basement or near a swimming pool.
5. Do not place the *CapTel* on an unstable cart, stand or table. The *CapTel* may fall, causing serious damage to the phone.
6. The *CapTel* should be operated only from the type of power source indicated on the marking label. If you are not sure of the type of power supply to your home, consult your dealer or local power company.
7. Do not allow anything to rest on the power cord. Do not locate the *CapTel* where people can walk on the cord.
8. Do not overload wall outlets and extension cords. This overloading can result in a fire or electric shock.
9. To reduce the risk of electric shock, do not disassemble the *CapTel*, but take it to a qualified service person when service or repair work is required. Opening or removing covers may expose you to dangerous voltages or other risks.

Incorrect re-assembly can cause electric shock when the *CapTel* is subsequently used.

10. Avoid using a telephone (other than a cordless type) during an electrical storm. There is a remote risk of electric shock from lightning.
11. Pressing the volume button may subject the user to dangerous volume levels.
12. Unplug the *CapTel* from the wall outlet and refer servicing to qualified service personnel under the following conditions:
  - a. When the power supply cord or plug is damaged or frayed.
  - b. If liquid has been spilled into the telephone.
  - c. If the telephone has been exposed to rain or water.
  - d. If the telephone does not operate normally by following the operating instructions. Adjust only those controls that are covered by the operating instructions. Improper adjustment of other controls may result in damage and will often require extensive work by a qualified technician to restore the telephone to normal operation.
  - e. If the telephone has been dropped and/or damaged.
  - f. If the telephone exhibits a distinct change in performance.
13. Do not use the telephone to report a gas leak in the vicinity of the leak.

# I N D E X

- Answering a call.....27
  - on an extension telephone .....27
- Answering Machine.....50
  - caption external answering machine messages .....62
  - clearing messages .....55
  - making messages audible .....60
  - playing messages .....52
  - record personal greeting.....56
  - setting number of rings.....58
  - turning on/off .....51
- Assistive listening devices..... 11, 29
  - using with *CapTel* 840i ..... 11, 29
- Audio jacks ..... 11
- Buttons .....6-9
  - Captions..... 6, 9, 22, 24, 25, 26  
.....27, 32, 52, 53, 67, 74, 92
  - CUST SERV (Customer Service).....8, back cover
  - Flash ..... 6, 8, 91
  - Mute ..... 6, 8
  - Redial.....6, 8
  - Tone..... 6, 9, 29
- Calls .....23
  - Making/answering calls.....23-27
  - Using Call History to see recent calls.....46-48
- Call History.....46
  - clearing all Caller ID entries.....49
  - deleting Caller ID entries ..... 48, 49
  - reviewing Caller ID entries ..... 47, 48
- Call Waiting.....8, 91
- Captions
  - button.....9, 21, 22, 24, 25, 26,  
.....27, 32, 52, 53, 67, 74, 76, 92, 95
  - changing color of captions.....40
  - changing size of captions .....38
  - corrections .....32
  - external answering machine messages .....62
  - reviewing captions after hanging up.....34
  - reviewing captions during a call.....33
  - saving captions after a call.....35
  - seeing captions of answering machine messages .....52
  - turning captions On/Off ..... 9, 24, 32
- Conversations
  - erase conversations.....37
  - review conversations.....34
  - save conversations .....35
  - smooth scroll .....42
- Corrections..... 32
- Customer Service
  - button .....8, back cover
  - calling for help.....8, back cover
  - Spanish customer service .....79
- Dialing
  - a phone number directly .....24
  - dialing 9 in an office setting ..... 24, 66, 69
  - from the Phone Book..... 26, 67
  - using Speed Dial buttons ..... 25, 74
- Display Screen
  - adjusting the brightness .....44
- External answering machine.....62



Flash button.....	8, 91	Reviewing Calls .....	33-35
Headsets, using with <i>CapTel</i> 840i.....	11	Ringer	
Internet		adjusting pitch.....	81
connecting to the Internet .....	15-20	adjusting volume .....	80
requirements .....	12	turning off (mute) .....	80
using a router .....	15	Scroll, captions on display .....	42
using WiFi .....	15-19	Set up.....	12
Lights, on keypad.....	82	help with set up .....	22, back cover
Messages, Answering Machine		requirements .....	12
clearing messages .....	55	using a router .....	15-19
external answering machine....	62-63	using wireless/WiFi.....	17
making messages audible/silent ...	60	Sharing a telephone line.....	96
playing messages .....	52	Signaler, using <i>CapTel</i> with .....	96
Mute button.....	8	Spanish	
Neckloop, using with .....	11, 29	captions .....	78
Network		customer service in Spanish.....	79
change settings .....	87	Speed Dial buttons	
view current settings.....	87-88	adding a name/number	
wireless/WiFi .....	17	to Speed Dial.....	72
Phone Book		dialing with the Speed	
adding a new contact to the		Dial buttons .....	25, 74
phone book.....	65	editing a name/number in	
dialing from the phone book ...	26, 67	Speed Dial.....	73
editing names/numbers in the		Telephone service requirements.....	12
phone book.....	68	Time and date, setting.....	20, 90
removing a contact from the		Tone	
phone book.....	70	adjusting for different	
Options		frequencies .....	29, 95
Answering Machine.....	50-63	button.....	29, 95
Call History.....	46	Update <i>CapTel</i> software .....	93
Conversations.....	33-37	Volume	
Dial from Phone Book .....	26, 67	adjusting the volume .....	9, 28, 95
Edit Phone Book .....	68	remembering on captioned calls....	84
Settings .....	75	Volume bar .....	9, 28
Redial button.....	8	Wireless/WiFi network.....	17-20, 87, 89
Register.....	21-22	removing saved networks .....	89
Reset (problem solving).....	95		

## FCC Information

The *CapTel* has been tested and found to comply with the specifications for a Class B digital device pursuant to Part 15 of the FCC Rules. These limits are designed to provide reasonable protection against harmful interference in a residential installation. This equipment generates and uses radio frequency energy and if not installed and used in accordance with the instructions, may cause harmful interference to radio communications. However, there is no guarantee that interference will not occur in a particular installation.

If this equipment does cause harmful interference to radio or television reception, which can be determined by turning the equipment off and on, the user is encouraged to try to correct the interference by one or more of the following measures:

- Reorient or relocate the receiving antenna.
- Increase the separation between the *CapTel* and the receiver.
- Connect the *CapTel* to an outlet on a circuit different from that to which the receiver is connected.
- Consult the dealer or an experienced radio/TV technician for help.

This equipment complies with Part 68 of the FCC rules and the requirements adopted by the ACTA. A label is located on the underside of the *CapTel* containing, among other information, an ACTA Product-Labeling Number, US:D8KTE00BCAPTEL840. If requested, this number must be provided to the telephone company.

A plug and jack used to connect this equipment to the premises wiring and telephone network must comply with the applicable FCC Part 68 rules and requirements adopted by the ACTA. A compliant telephone cord and modular plug is provided with this product. It is designed to be connected to a compatible modular jack that is also compliant. See installation instructions for details.

The REN is used to determine the quantity of devices which may be connected to the telephone line. Excessive RENs on the line may result in the devices not ringing in response to an incoming call. In most, but not all, areas the sum of RENs should not exceed five (5.0). To be certain of the number of devices that may be connected to a line, as determined by the total RENs, contact the local telephone company. The REN for this product is 0.0B.

Should you experience trouble with this telephone equipment, please contact:

CapTel Customer Service  
450 Science Drive  
Madison, WI 53711  
Phone: 888-269-7477 V/TTY  
Email: CapTel@CapTel.com

For repair or warranty information, please contact *CapTel* Customer Service at 1-888-269-7477 (V/TTY). If the equipment is causing harm to the telephone network, the telephone company may request that you disconnect the equipment until the problem is resolved.

This equipment cannot be used on public coin phone service provided by the telephone company. Connection to party line service is subject to state tariffs.

If the *CapTel* causes harm to the telephone network, the telephone company will notify you in advance that temporary discontinuance of service may be required. But, if advance notice is not practical, the telephone company will notify you as soon as possible. Also, you will be advised of your right to file a complaint with the FCC if you believe it is necessary.

Occasionally, your telephone company may make changes in its facilities, equipment, operation, or procedures that could affect the operation of your equipment. If so, you will be given advance notice of the change to give you an opportunity to maintain uninterrupted service.

If your home has specially wired alarm equipment connected to the telephone line, ensure the installation of the *CapTel* does not disable it. If you have questions about what will disable alarm equipment, consult your telephone company or a qualified installer.

The *CapTel* telephone does not have any user-serviceable parts. Modification or changes to the *CapTel* not expressly approved by Ultratec, Inc. can void your authority to operate the equipment.

*CapTel* is the latest innovation from  **Ultratec**.

Ultratec, Inc.

450 Science Drive

Madison, WI 53711

(888) 269-7477 V/TTY

(866) 670-9134 (Spanish *CapTel* Customer Service)

Email: [CapTel@CapTel.com](mailto:CapTel@CapTel.com) • Fax: (608) 204-6167 • Web: [www.CapTel.com](http://www.CapTel.com)

©2015 Ultratec, Inc. All rights reserved.

Ultratec and *CapTel* are registered trademarks of Ultratec, Inc.

# Getting Help

---

If you have any questions, comments, or concerns as you use your new *CapTel* 840i, we're here to help. Use any of these ways to contact us:

CUST  
SERV



## **CUST SERV Button**

Pick up the handset and press the **CUST SERV** button to automatically speed dial directly to our helpful Customer Service team. If you are in an office setting, you may need to dial "9" first and then press the **CUST SERV** button. *(Available 24 hours a day, 7 days a week. Closed on major holidays.)*

Help materials are also available online at our website.



Phone: 1-888-269-7477 *(Available 24 hours a day, 7 days a week)*

FAX: (608) 204-6167



Mail: CapTel Customer Service  
450 Science Drive  
Madison, WI 53711



Email: [CapTel@CapTel.com](mailto:CapTel@CapTel.com)

Online: [www.CapTel.com](http://www.CapTel.com)

*(Live Chat help available at our website)*